

# AC VACUUM CIRCUIT BREAKER

Type **MACS**

RAIL VEHICLES

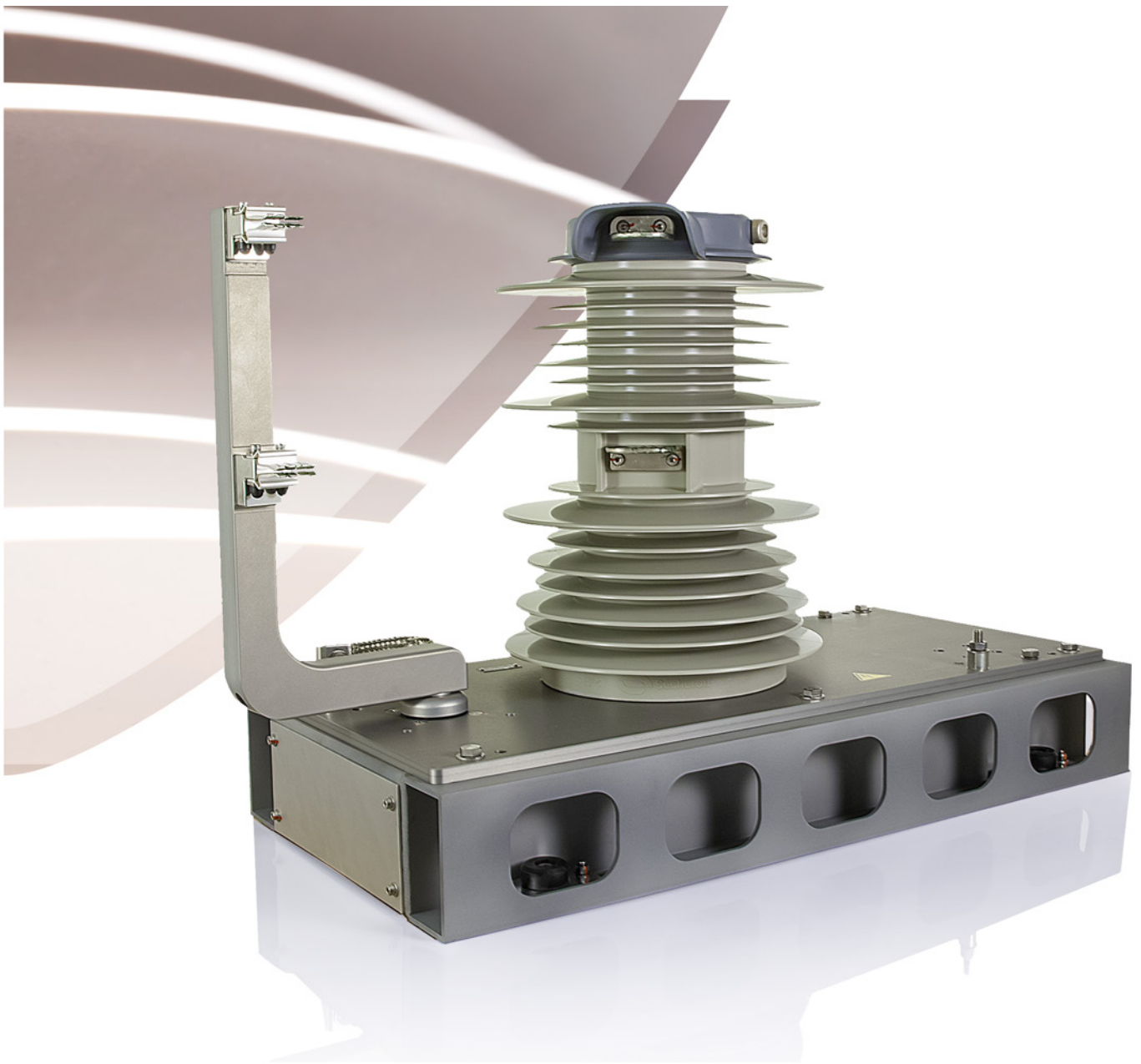

# GENERAL INFORMATION

**MACS** is Sécheron's main circuit breaker platform for installation on AC and AC/DC rail vehicles. It offers car builders a highly modular platform which is ideally suited to their various applications and requirements.

MACS is a fully electrically operated circuit breaker, designed to automatically open through spring release if the low voltage supply is interrupted.

Among the large range of options offered by MACS, two are unique features in the market for rail vehicle vacuum circuit breakers. The **overcurrent detection and tripping function**, ensures the autonomy of the circuit breaker in detecting, tripping and interrupting overcurrents and short circuits. The **Point-on-Wave (PoW)/Synchronous switching**, enables the MACS breaker to be closed or/and open synchronously with any phase angle of the line voltage, enabling a smart

mitigation of Electromagnetic Interferences (EMI) or/ and transformer's inrush currents.

Sécheron offers many options to facilitate the integration of the circuit breaker on the vehicle. Delivered as a standalone component, the MACS can be supplied with a roof box to limit roof cut-outs, as well as noise transmission. It can also be delivered with other high voltage functions, such as current and voltage measurements, disconnectors and surge arresters, as part of Sécheron's high voltage integrated systems type **AC MODFRAME** or **AC MODBOX**®.

The MACS lightweight platform with its modularity and compact dimensions is the perfect solution for your rolling stock running on 15 kV<sub>AC</sub> and/or 25 kV<sub>AC</sub> networks.

## AC/DC TYPICAL APPLICATIONS

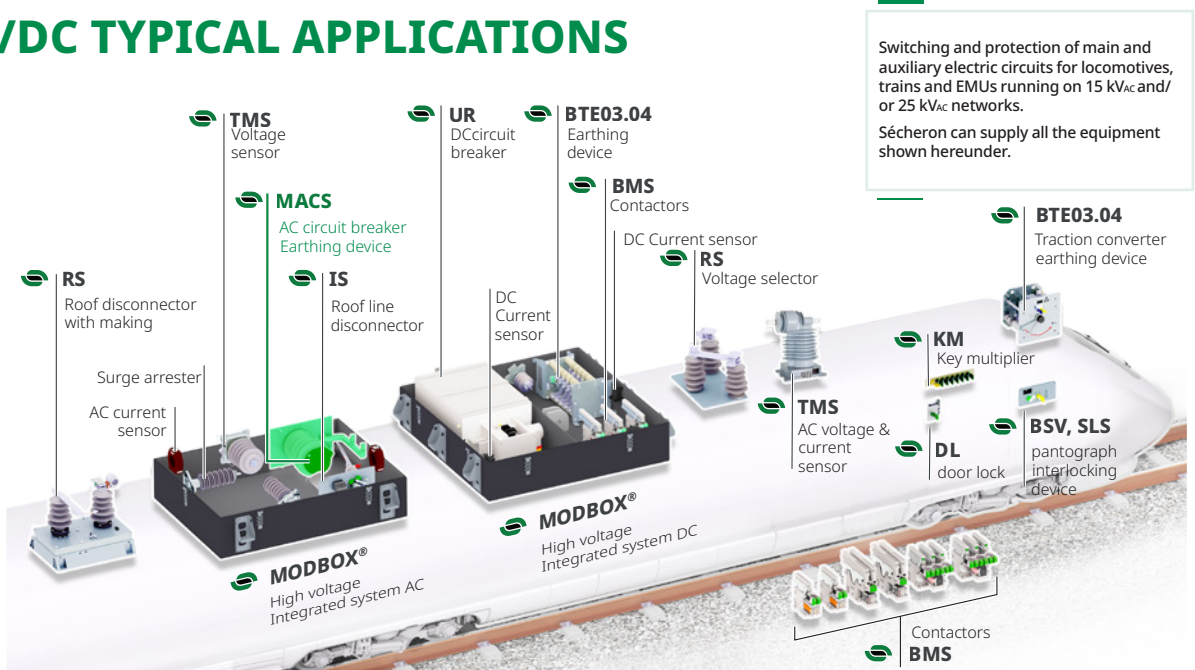

## PRODUCT RANGE

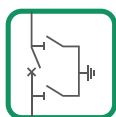

AC circuit breakers with earthing device

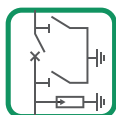

& with surge arrester

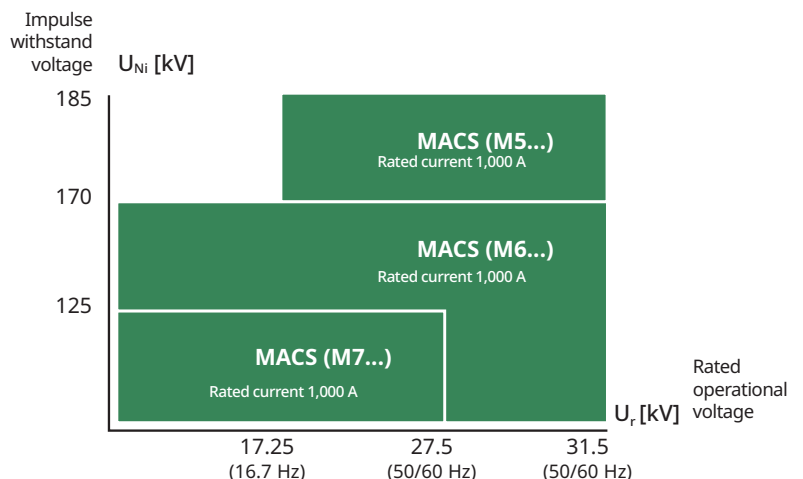

## MAIN FEATURES

- Compact multi-functional switch incorporating: AC circuit breaker, earthing device and optional surge arrester on a single 940 mm x 430 mm footprint.

For integration of roof disconnect switch, contact Sécheron.

### // AC CIRCUIT BREAKER

- Suitable for 15 kV<sub>AC</sub> and/or 25 kV<sub>AC</sub> networks.
- Conventional free air thermal current 1,000 A.
- Rated impulse withstand voltage (1.2 / 50 μs):  
U<sub>Ni</sub> = 125 kV, 170 kV and 185 kV.
- External creepage distances  
> 1,000 mm (U<sub>Ni</sub> = 125 kV and 170 kV)  
> 1,250 mm (U<sub>Ni</sub> = 185 kV).
- Electric operation (closing and holding).
- Operation in ambient temperature from -40 °C to +70 °C (-50 °C to +70 °C in option).
- Reference standards: IEC/EN 60077-4, IEC/EN 61373, EN 50121-3-2, EN 45545.

### // EARTHING DEVICE

- Integrated earthing device with manual or electric operation.
- Safe manual operation guaranteed through interlocking keys.
- Ice breaking capability (20 mm ice).

### // SURGE ARRESTER

- Optional integrated surge arrester (to be defined by Sécheron upon customer's specifications).

## MAIN BENEFITS

- ✓ Indoor or outdoor installation.
- ✓ Vertical or horizontal mounting.
- ✓ Specific version (U<sub>Ni</sub> = 185 kV) with increased insulation level for outdoor operation in harsh environmental conditions (pollution, humidity, etc.).
- ✓ High level of safety thanks to automatic opening via spring release (no need for stored auxiliary electrical energy).
- ✓ Wide range of configurations and options to suit all operating conditions and requirements.
- ✓ Optional overcurrent detection and tripping function
- ✓ Optional Point-on-Wave/Synchronous switching at closing or/and opening, to mitigate against electromagnetic interferences or/and inrush currents.
- ✓ Optional roof box to limit roof cut-outs and structural noise transmission.
- ✓ Can be delivered integrated with other high voltage components in the AC MODFRAME for roof open air installation.
- ✓ Can be supplied with other high- and low- voltage components inside MODBOX® to mitigate operational risks from harsh environmental conditions (ice, sand, etc.).
- ✓ Compliant with LOC & PAS TSI, 1302/2014/EU.
- ✓ Specific configurations can also be developed for particular environments.
- ✓ Experts with a comprehensive understanding of working environments and coordination of protective devices.

# DATA FOR PRODUCT SELECTION

		Symbol	Unit					
<b>MAIN HIGH VOLTAGE CIRCUIT</b>								
<b>AC circuit breaker</b>								
Application		Single & dual voltage				Harsh environment		
MACS designation code		M7		M6		M5		
Nominal voltage	$U_n$	[kV]	15	25	15	25	25	
Rated operational voltage	$U_r$	[kV]	17.25 <sup>(1)</sup>	27.25 <sup>(1)</sup>	17.25 <sup>(1)</sup>	31.5 <sup>(1)</sup>	31.5 <sup>(1)</sup>	
Rated insulation voltage	$U_{Nm}$	[kV]	30		31.5		33	
Rated operational frequency	$f_r$	[Hz]	16.7	50 & 60	16.7	50 & 60	50 & 60	
Rated impulse withstand voltage (1.2/50 $\mu$ s)	$U_{Ni}$	[kV]	125		170		185	
Rated power-frequency withstand voltage (50 Hz, 1 mn)								
- Pole-pole	$U_a$	[kV]	75		80		85	
- Pole-earth	$U_a$	[kV]	75		80		100	
Conventional free air thermal current <sup>(2)</sup>	$I_{th}$	[A]	1,000		1,000		1,000	
Rated operational current	$I_r$	[A]	1,000		1,000		1,000	
Operational category		C3		C3		C3		
Peak short-circuit making current	$I_{MC}$	[kA]	62.5	50	62.5	50	50	
Rated short-circuit breaking current	$I_{BC}$	[kA]	25	20	25	20	20	
DC component for asymmetrical breaking current		%		$\leq 50$		$\leq 50$		$\leq 50$
Peak and rated short-time withstand current (1 s)	$\hat{I}_{cw}/I_{cw}$	[kA]/[kA]	62.5/25		62.5/25		62.5/25	
Short-time withstand current (0.1 s)	$I_{cw}$	[kA]	40	-	40	-	-	
Minimum creepage distances		[mm]	$> 1,000$		$> 1,000$		$> 1,250$	
<sup>(1)</sup> For other values, please contact Sécheron. • <sup>(2)</sup> At $T_{amb} = +40$ °C and tested with high voltage connections according to standard IEC/EN 60943.								
<b>Earthing device</b>								
Peak and rated short-time withstand current (1 s)	$\hat{I}_{cw}/I_{cw}$	[kA]/[kA]	62.5/25		62.5/25		62.5/25	
<b>LOW VOLTAGE AUXILIARY CIRCUIT</b>								
<b>Control circuit</b>								
<b>AC circuit breaker</b>								
Nominal voltage (power supply and control order)	$U_n$	[V <sub>ac</sub> ]	24 to 110					
Range of voltage (power supply and control order)		[0.7 - 1.25] $U_n$						
Maximum power (loading and holding) <sup>(3)(4)</sup>	$P_{max}$	[W]	$\leq 180$ (depends on battery voltage)					
Nominal holding power <sup>(4)</sup>	$P_h$	[W]	$\leq 35$					
Opening power		[W]						
Mechanical opening time <sup>(4)</sup>		[ms]						
Mechanical closing time <sup>(4)</sup>		[ms]						
<b>Earthing device (electrically operated version)</b>								
Nominal voltage	$U_n$	[V <sub>ac</sub> ]	24, 32, 36, 48/50, 72, 110					
Operating power <sup>(4)</sup>		[W]						
Commutation time <sup>(4)</sup>		[s]						
<sup>(3)</sup> Loading time < 12 seconds. • <sup>(4)</sup> At $U_n$ and $T_{amb} = +23$ °C.								
<b>Auxiliary contacts</b>								
Type of contacts		Potential free						
Rated voltage		[V <sub>ac</sub> ]						
Conventional thermal current		[A]						
Switching categories according to EN60947 (silver contacts)		AC - 15 230 V <sub>ac</sub> 1.0 A DC - 13 110 V <sub>dc</sub> 0.5 A						
Minimum let-through current at 24 V <sub>dc</sub> <sup>(5)</sup>		[mA]						
<b>AC circuit breaker</b>								
Quantity		4a+4b (standard) / 4a+4b (additional in option) <sup>(6)</sup>						
<b>Earthing switch</b>								
Quantity		0 (standard) / 2a+2b (option) - For manual earthing switch 2a+2b (option) - For electric earthing switch						
<sup>(5)</sup> For a dry and clean environment. <sup>(6)</sup> For MACS version with Point-on-Wave/Synchronous switching, only 2a+2b additional in option. •								
<b>Low voltage interface</b>								
Type of connection <sup>(7)</sup>								
- AC VCB with manual earthing device		1 Connector: Harting 51 P						
- AC VCB with electric earthing device		2 Connectors: Harting 51 P + Harting 24 DD						
- Voltage analog input for synchronous switching		1 connector Harting Han 3A						
- Current analog input for overcurrent detection and tripping		1 connector Harting Han 3A						
<sup>(7)</sup> Refer to page 12 for mobile connector information.								
<b>Insulation</b>								
Rated power-frequency withstand voltage (50 Hz, 1 mn)	$U_a$	[kV]	1.5					
<b>OPERATING CONDITIONS</b>								
Installation		Indoor or outdoor						
Altitude		[m]						
Working ambient temperature		$T_{amb}$ [°C]						
Humidity		Class 5K2						
Pollution degree		[IP]						
Minimum mechanical durability		N [Cycles]						

# PRODUCT INTEGRATION

## INTEGRATION RULES AND SRACS

Important integration rules and Safety Related Application Conditions (SRACs) apply for the integration of MACS and its options. They are detailed in the instruction manual, available on request.

## MAIN DIMENSIONS

Dimensions without tolerances are approximate only. All dimensions given in mm.  
HV and earth connections: M12 screws.

### AC CIRCUIT BREAKER 15/25 kV<sub>AC</sub> - U<sub>Ni</sub> = 125 kV (MACS M7.. DESIGNATION CODE)

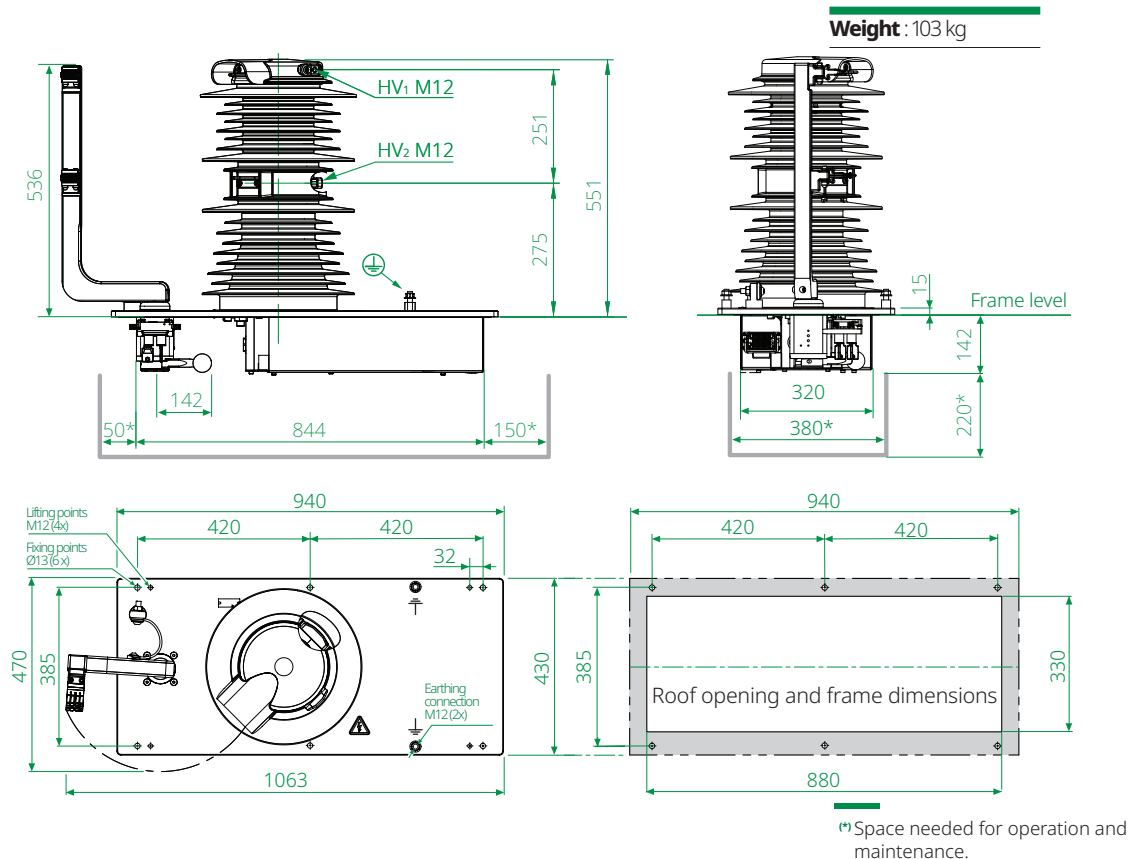

### AC CIRCUIT BREAKER 15/25 kV<sub>AC</sub> - U<sub>Ni</sub> = 170 kV (MACS M6.. DESIGNATION CODE)

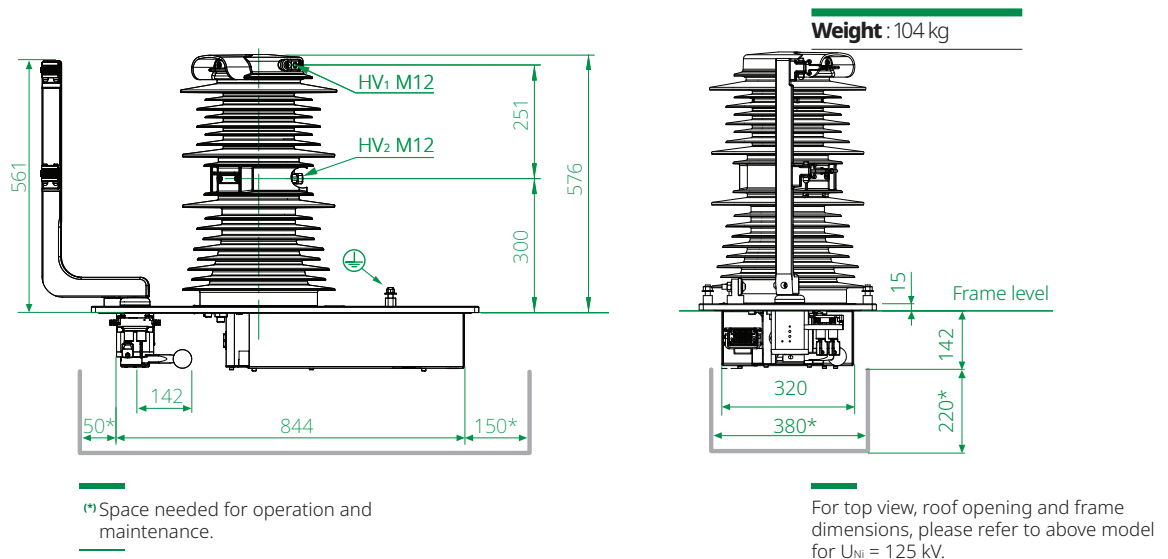

## AC CIRCUIT BREAKER 25 kV<sub>AC</sub> - U<sub>Ni</sub> = 185 kV (MACS M5.. DESIGNATION CODE)

**Weight** : 105 kg

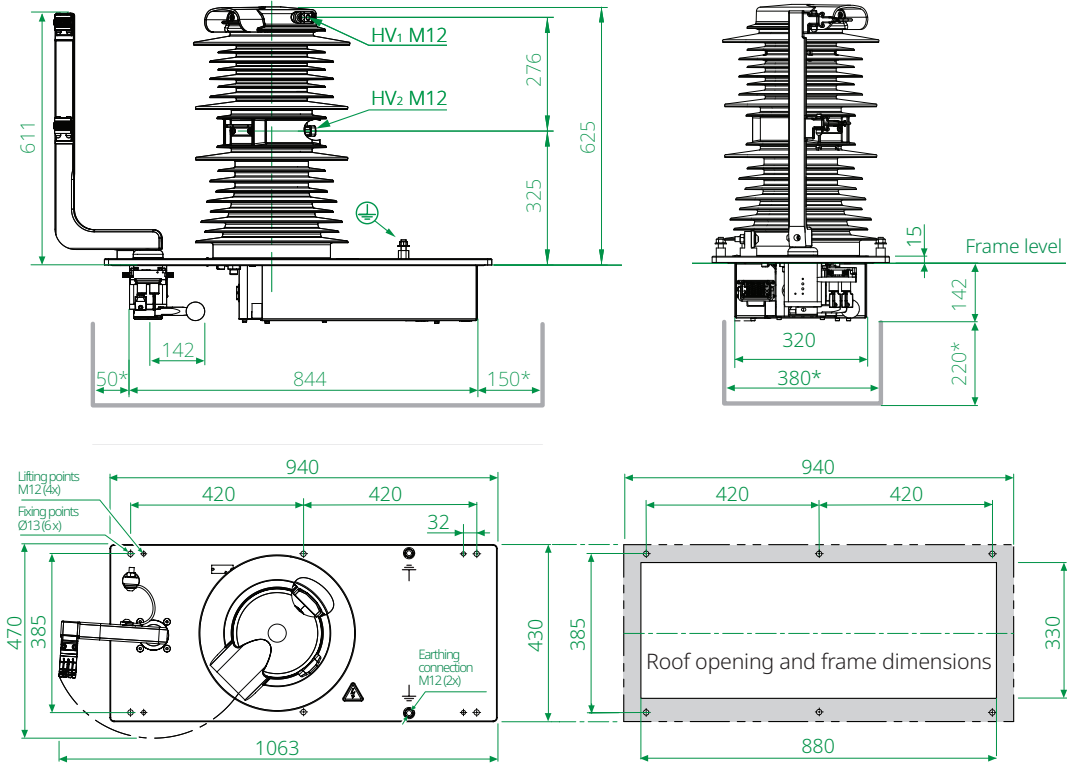

\* Space needed for operation and maintenance.

## INSTALLATION POSSIBILITIES

### VERTICAL INSTALLATION ON THE ROOF (WITH ROOF CUT-OUT)

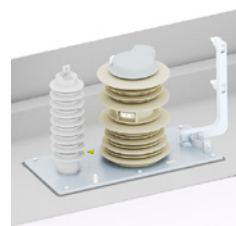
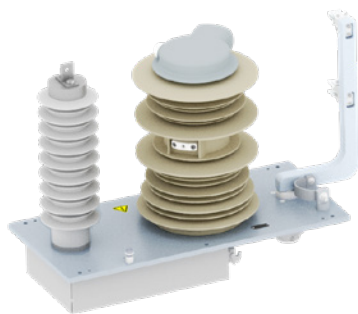

With this solution a roof cut-out is required for the MACS low voltage compartment as well as for the manual operating mechanism of the earthing device.

### VERTICAL INSTALLATION ON THE ROOF (WITHOUT ROOF CUT-OUT)

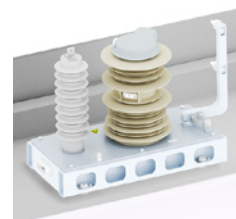
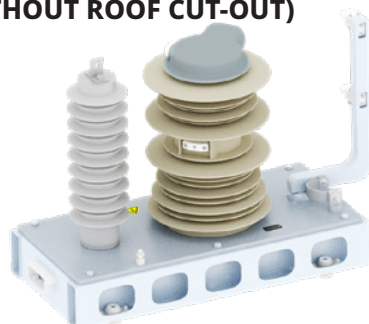

To avoid roof cut-out while reducing structural noise transmission, MACS can also be delivered together with Sécheron's optional roof box.

## HORIZONTAL INSTALLATION ON THE ROOF OR UNDERFRAME

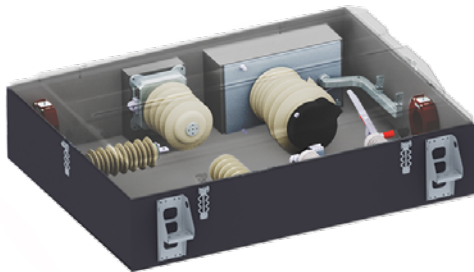

Underframe mounting or roof mounting in special high voltage box (Sécheron **AC MODBOX®**).

## LOW VOLTAGE WIRING DIAGRAM (HARTING HAN® MODULAR 51-PINS CONNECTOR)

Legend of the schemes:

	Circuit breaker main contacts		Low voltage connector interface (male pin)
	Earthing device main contacts		1a + 1b - switch PF
	Closing coils		Earthing device manual operation
	Harting connector		Optional auxiliary contact
			Optional auxiliary contact when Sync and/or Overcurrent protection functions
B	Battery power supply	O	Control order
R	Ready switch (MACS ready to close)	ES	Earthing device

The representation below depicts **MACS** in standard configuration (4a+4b – switch PF), with optional additional auxiliary switches (4a+4b – switch PF) and manual earthing device (2a+2b – switch PF).

For electric earthing device, please contact Sécheron.

- The auxiliary switches' state is represented for the MACS in open position.

- The auxiliary switches' state is represented for the earthing device in position not grounded and locked in this position.

- For the MACS version with Point-on-Wave/ Synchronous switching option, maximum number of available auxiliary switches is 6 (4 as standard + 2 as option).

- In case you order the MACS configuration with the optional functions, synchronous switching or/and overcurrent detection and tripping, thank you to ask Sécheron for the related specific control scheme.

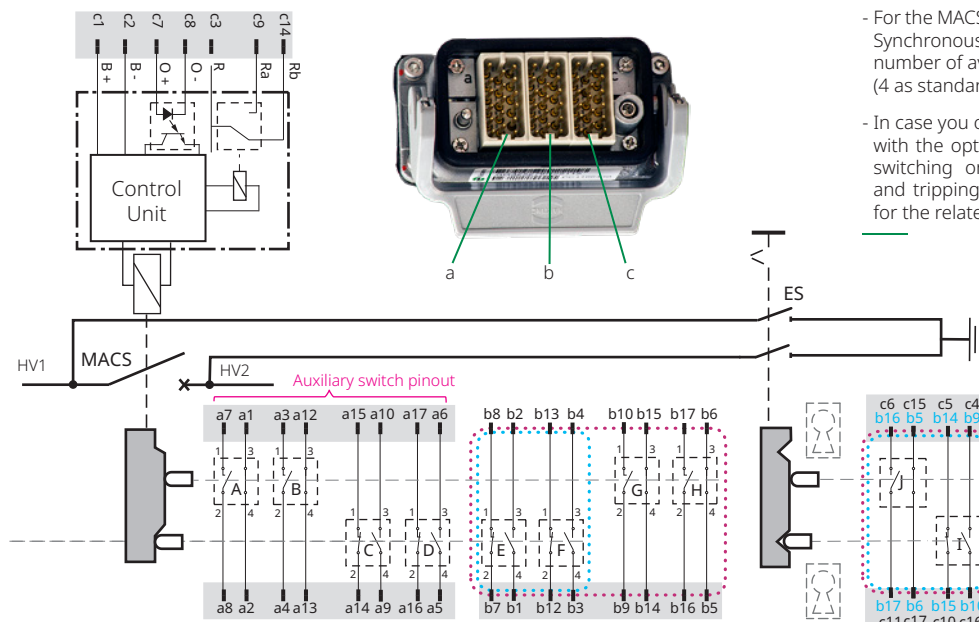

Pinout for standard version  
Pinout when Sync and/or  
Overcurrent protection function

# OPTIONS (SUBJECT TO ADDITIONAL COSTS)

## EARTHING DEVICE - ELECTRIC OPERATION

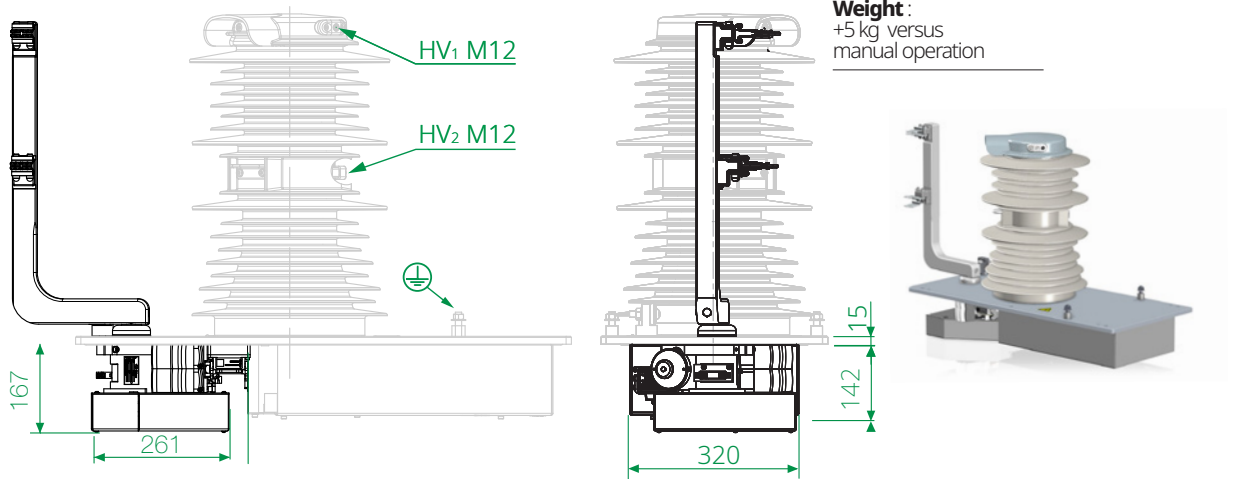

## INTEGRATION OF SURGE ARRESTER

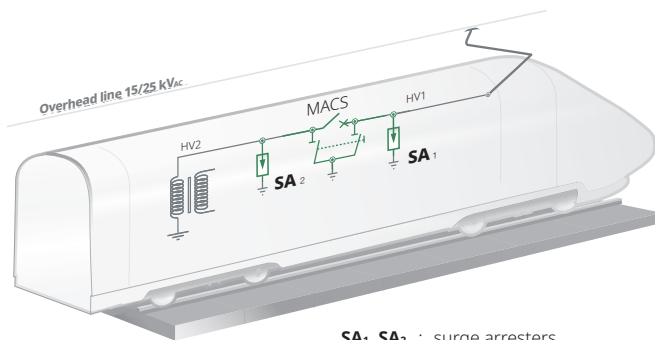

**SA<sub>1</sub>, SA<sub>2</sub>** : surge arresters  
**MACS** : AC vacuum circuit breaker + earthing device

For safe and efficient protection against lightning and switching overvoltages, Sécheron strongly recommends the use of two surge arresters SA<sub>1</sub> and SA<sub>2</sub> in the vehicle's high voltage circuit.

In order to effectively protect the AC circuit breaker, the distance between each surge arrester and the AC circuit breaker must not be too long.

Customers wishing to add a surge arrester to the MACS can rely on Sécheron's specialists to specify the most appropriate type.

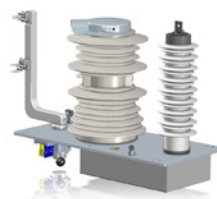

The connection between the AC circuit breaker and the surge arrester is not shown on the drawing but can also be delivered by Sécheron.

Weight and height of surge arresters depend on selected type.

Surge arrester connections: M12 screws.

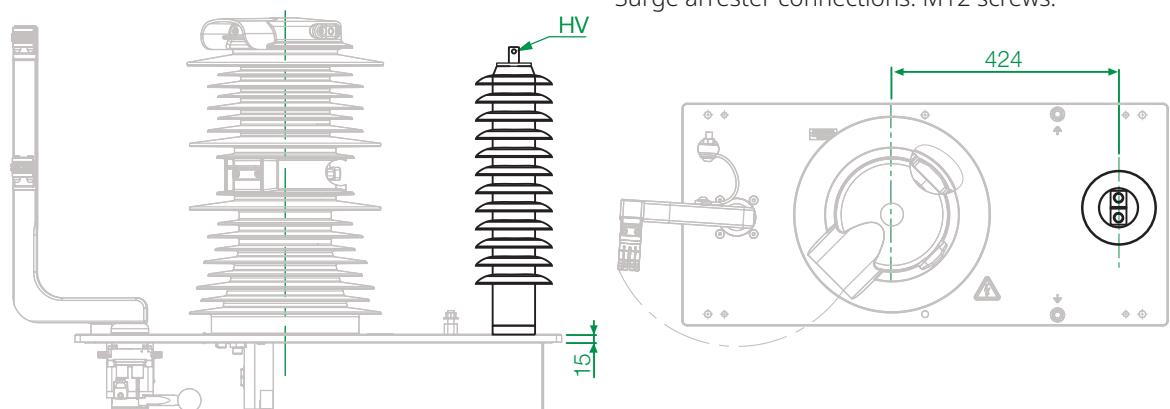

## OVERCURRENT DETECTION AND TRIPPING FUNCTION

The **short-circuit and overcurrent detection and self-tripping function** ensures the autonomy of the **MACS** in detecting, tripping and interrupting overcurrents and short circuits.

This function requires an input from the current transformer that measures the vehicle input current. This signal can be provided either by Sécheron TMS current & voltage sensor, or by a current transformer.

Two types of overcurrent detection are achieved through different thresholds and reaction times:

- Instantaneous maximum current / short-circuit detection
- RMS current overcurrent detection

When the detection of one of these events is proven, MACS main contacts automatically open with its usual mechanical opening time.

Whenever short-circuits or overcurrents are detected, a relay integrated in the MACS control unit provides the information to the vehicle.

A series of protocols and security measures are implemented for this highly critical function to ensure safe operations and monitoring of the MACS as well as hazards mitigation.

Reclosing the MACS immediately after short-circuit conditions is prevented, as well as after a series of overcurrent detections.

This major innovation further enhances the vehicle safety, as it avoids dividing safety functions and responsibilities among several devices and vehicle's stakeholders, which is a common practice today for AC circuit breakers available on the market

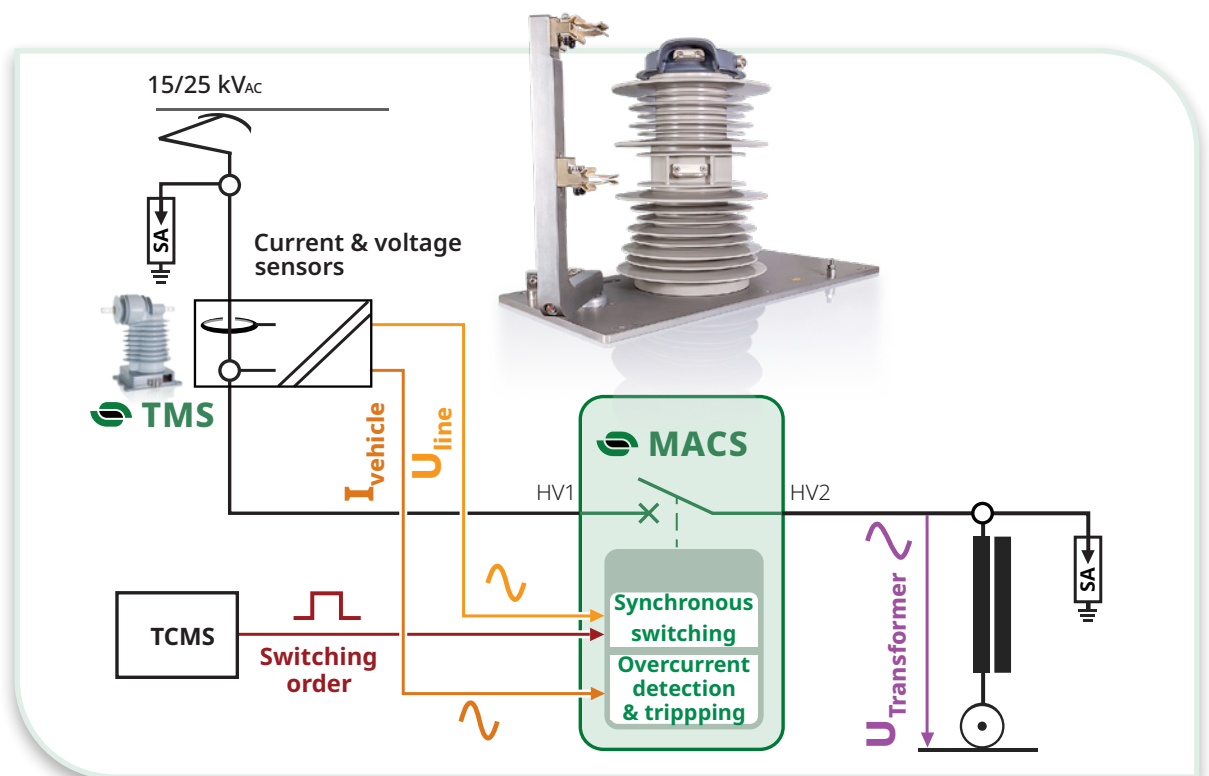

## SHORT CIRCUIT DETECTION & TRIPPING

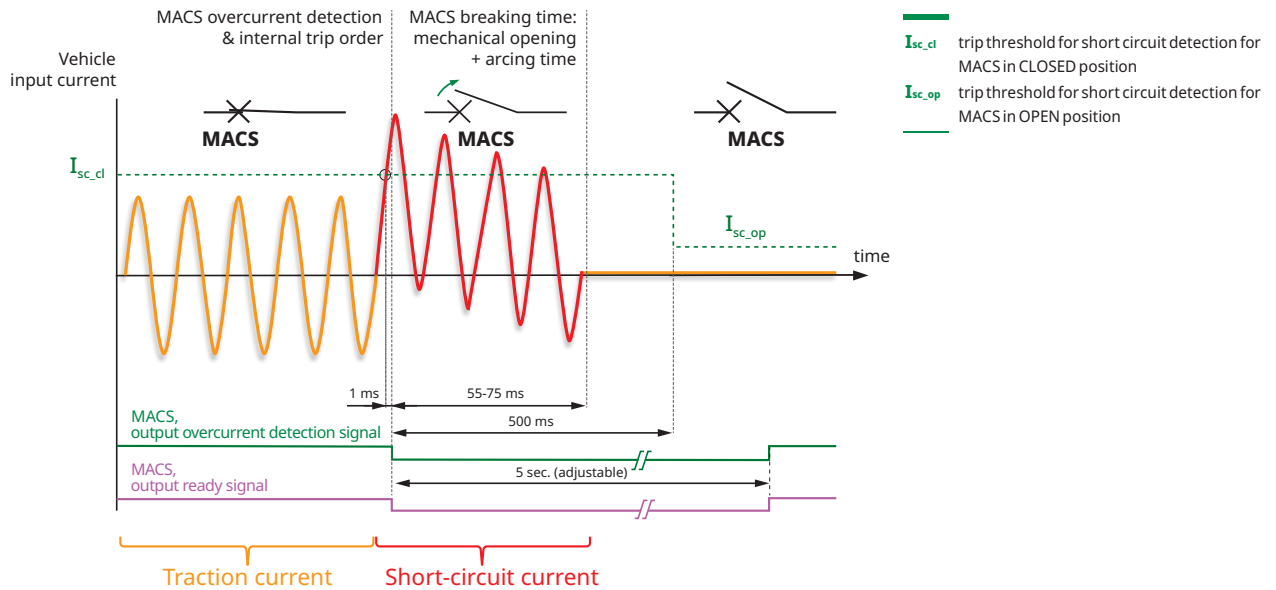

## RMS DETECTION & TRIPPING

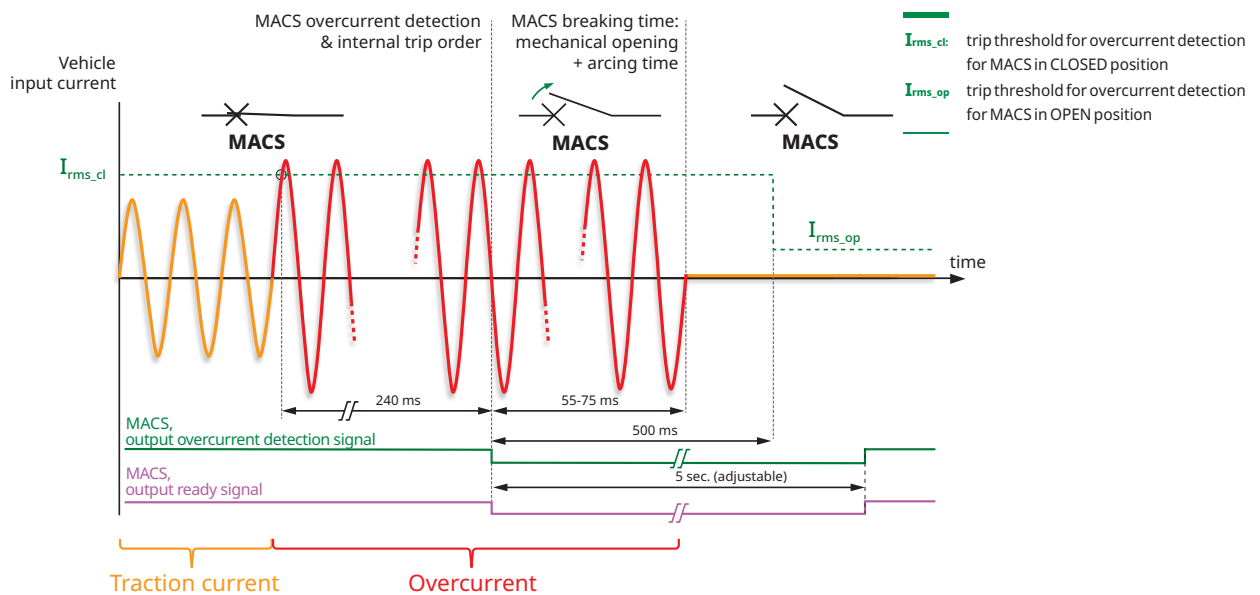

## MAIN BENEFITS

- ✓ Built-in detection and tripping function for an autonomous protection against overcurrents and short-circuits.
- ✓ Enhanced vehicle safety with an AC circuit breaker no longer depending on third party detection and trip signals.
- ✓ Adjustable thresholds for detection and tripping of overcurrents and short-circuits.
- ✓ Different detection thresholds for MACS in CLOSE and OPEN positions to detect any unsafe operating condition.
- ✓ Function's failure rate complies with Safety Integrity Level 2 (SIL2).
- ✓ Can be selected together with point-on-wave/synchronous switching function.

## REQUIREMENTS FOR MACS OVERCURRENT DETECTION AND TRIP FUNCTION

- Have one AC current sensor analogue output available for connection to the MACS control unit.
- The input can come from Sécheron's TMS or from a Current Transformer.
- MACS analogue input: from 0.25 to 5 A<sub>AC</sub>.
- Define the detection/trip thresholds for the overcurrents and short-circuits protections.
- Define the delay time before authorizing to reclose the MACS after a detection and trip of an overcurrent/short-circuit.
- Select the appropriate code (H, N or P) for the line 21 of the ordering code (page 19).
- Order the additional low voltage connector for the current analogue input signal on MACS.

## POINT-ON-WAVE/SYNCHRONOUS SWITCHING FUNCTION

Sécheron has designed a unique **Point-on-Wave/Synchronous switching** function that can be installed on our AC circuit breakers type **MACS**. This function enables to close or/and open repetitively the MACS on a predefined phase angle of the line voltage and with a typical accuracy within  $\pm 1$  ms ( $\pm 18$  degree at 50 Hz). With this function, MACS can for instance be closed on the phase 0 degree (or

180 degrees) so that the main contacts closes at the exact time when the line voltage is 0 volts, avoiding thus high dv/dt and limiting induced potential electromagnetic interferences. If closing on the phase 90 degrees (or 270 degrees) is selected, the AC circuit breaker will close when the value of the line voltage wave is at its maximum, minimizing the vehicle inrush current.

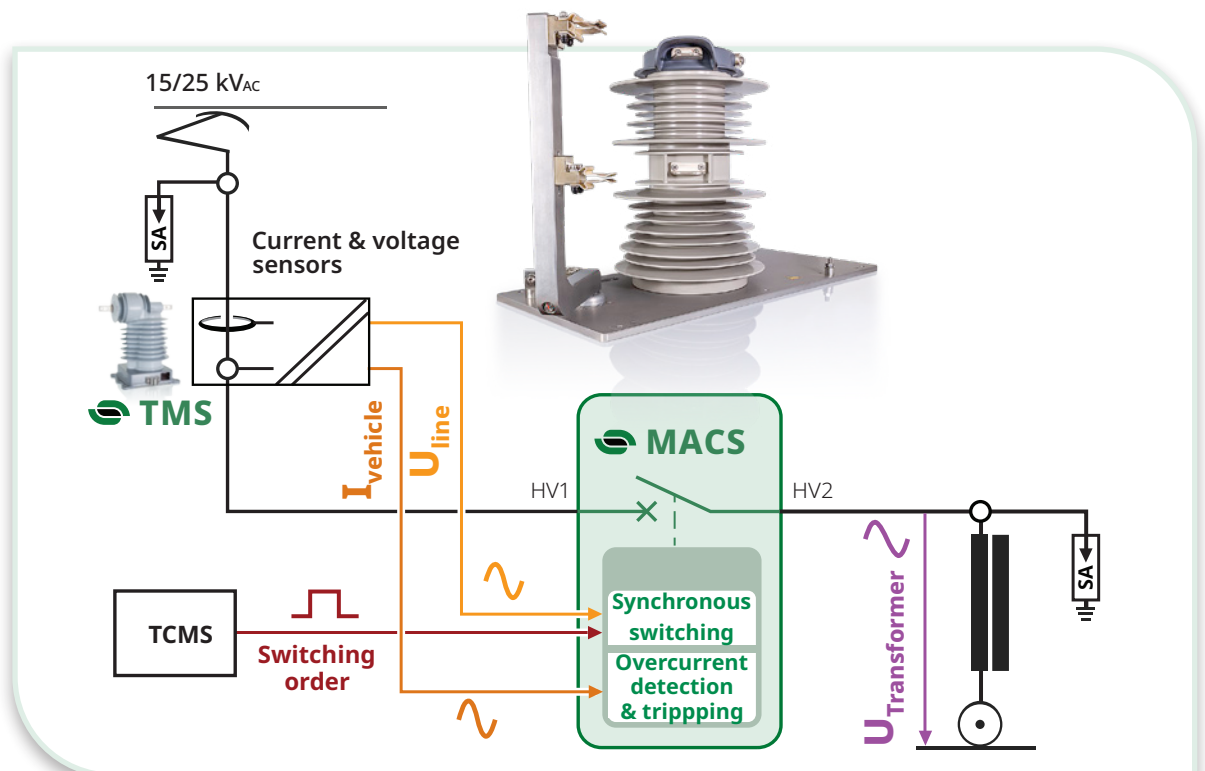

### Closing synchronous switching at 0°

⇒ Reduction of Electromagnetic interference (EMI)

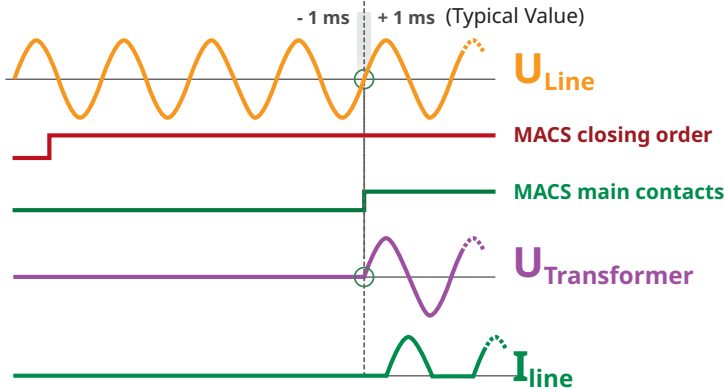

### Closing synchronous switching at 90°

⇒ Reduction of transformer's inrush current

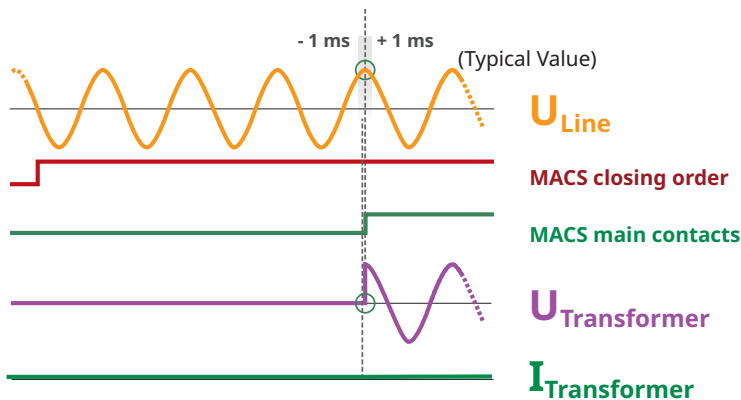

## MAIN BENEFITS

- ✓ Synchronous switching of the MACS with the line voltage phase.
- ✓ Adjustable setting of the predefined phase angle of line voltage for synchronous closing or/and opening.
- ✓ Setting of the predefined phase angle can be different for closing and opening.
- ✓ High accuracy for Point-on-Wave/Synchronous switching, typically within  $\pm 1$  ms.
- ✓ Switching accuracy independent from the ambient temperature and control voltage.
- ✓ Suitable for 12 kV (25 Hz), 15 kV (16.7 Hz), 25 kV (50 & 60 Hz).
- ✓ Reliable closing at 0 Volts crossing to avoid dV/dt and subsequent electromagnetic interferences.
- ✓ Reliable closing at maximum voltage of the sine wave to limit vehicle inrush current.
- ✓ Point-on-Wave/Synchronous switching function can be directly integrated in the MACS control unit with no impact on the product's dimensions.
- ✓ Can be selected together with overcurrent detection and tripping function.

## REQUIREMENTS TO ORDER POINT-ON-WAVE/SYNCHRONOUS SWITCHING FUNCTION

- Have one AC voltage sensor's analogue output available for connection to the MACS control unit. The input can come from Sécheron's **TMS** voltage & current sensor (current loop output) or from a Voltage Transformer (voltage output).  
MACS input voltage range:
  - from 37.5 to 120 V<sub>AC</sub> <sup>(1)</sup>
  - 8 to 25 mA
- Define precisely the goal to be achieved using the Point-on-Wave/Synchronous switching function, so that Sécheron can recommend the best settings adapted to your application and requirements: reduce Inrush Current, reduce Electromagnetic Interferences (EMI), others, ....
- Upon the needs of the application, the synchronous switching behaviour of the orders can be set in different modes
  - Point-on-Wave/Synchronous switching at closing only (at any predefined phase)
  - Point-on-Wave/Synchronous switching at opening and closing (at any predefined phase angle, possibly different than closing phase angle).

### Order 1 trip orders

- ✓ Overcurrent or short-circuit
- ✓ Instant opening
- ✓ priority order

### Order 2 switching orders

- ✓ Normal operating conditions
- ✓ Synchronous switching
- ✓ Delayed closing or/and opening



For the Point-on-Wave/Synchronous switching function you can also refer to our below brochure.

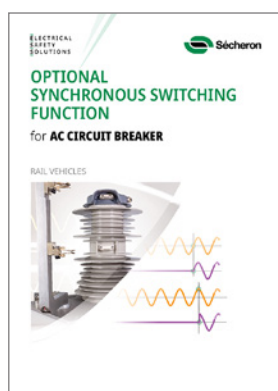

Brochure  
Synchronous switching  
AC circuit breakers  
SA013236BEN

<sup>(1)</sup> for other voltage ranges, please contact Sécheron.

Please note that in case the Point-on-Wave/Synchronous switching option is selected, the maximum number of auxiliary switches for the MACS is limited to 6 instead of 8 (4 as standard + 2 as option).

## ROOF BOX

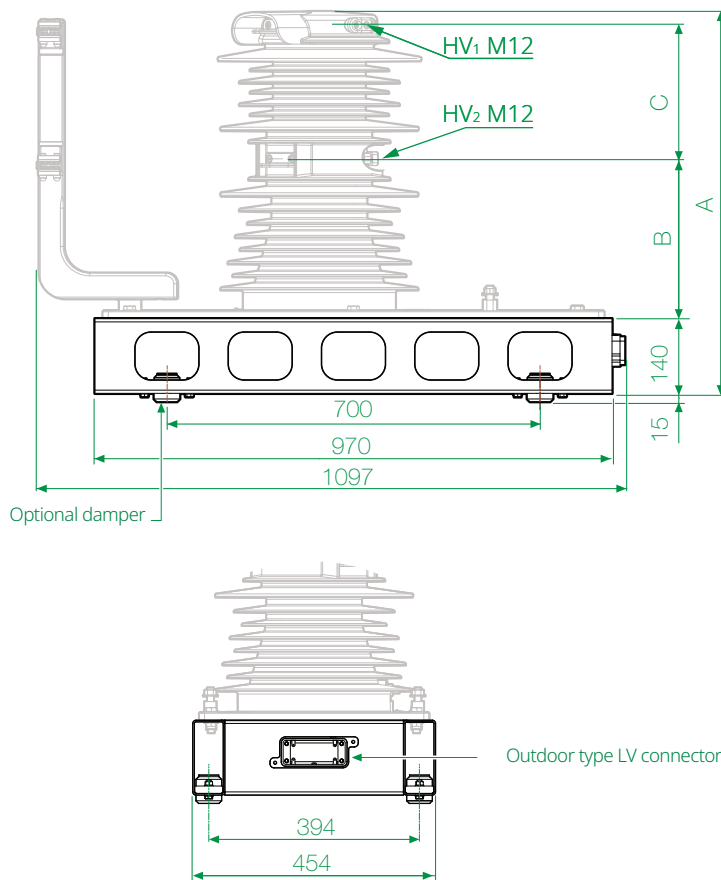

### Main dimensions:

Refer to the table below

	MACS designation code		
	M7	M6	M5
<b>U<sub>Ni</sub> [kV]</b>	125	170	185
<b>A (mm)</b>	691	716	766
<b>B (mm)</b>	275	300	325
<b>C (mm)</b>	251	251	276

Roof box dimensions are only indicative.

Selecting the optional electrically operated earthing device together with the roof box, will limit the roof crossing to the low voltage connections.





















In case the manual earthing device is selected with the optional roof box, a roof crossing for the earthing device manual operation as well as for the low voltage connections is to be foreseen.

## MAIN BENEFITS

- ✓ No roof cut-out required to install the AC circuit breaker.
- ✓ No roof cut-out if the optional electric version for earthing device is selected.
- ✓ Reduced size hole in roof for the operating mechanism of the manual earthing device.
- ✓ Substantial reduction in noise transmission through the car body structure.
- ✓ Structural validation according to EN 12663.
- ✓ Validated for vibrations & shocks according to IEC/EN 61373.

## LOW VOLTAGE MOBILE CONNECTOR THROUGH ROOF INSTALLATION (HARTING HAN® MODULAR 51-PINS CONNECTOR)





### MOBILE CONNECTOR FOR MACS

MACS configurations			Mobile connectors					
Auxilliary Switches			Type	Number of pin		Cable gland	Cable entry	Secheron's reference
Options	Manual ground switch	Auxiliary switches number		Size 2.5 mm <sup>2</sup>	Size 1.5 mm <sup>2</sup>			
None	No	4	Harting HAN® Modular 51 pins	-	23	M25		SG325249R00101
								SG325249R00201
None	Yes	4		-	32	M32		SG325249R00303
								SG325249R00403
2 Orders	No	4		-	32	M32		SG325249R00303
								SG325249R00403
2 Orders	Yes	4		-	40	M32		SG325249R00302
								SG325249R00402
Sync and/or OCP	No	4		-	32	M32		SG325249R00303
								SG325249R00403
Sync and/or OCP	Yes	4		-	40	M32		SG325249R00302
								SG325249R00402
None	No	8		-	40	M32		SG325249R00302
								SG325249R00402
Sync and/or OCP	No	6		-	40	M32		SG325249R00302
								SG325249R00402
None	Yes	8	-	48	M32		SG325249R00304	
							SG325249R00404	
Sync and/or OCP	Yes	6	-	48	M32		SG325249R00304	
							SG325249R00404	

### LOW VOLTAGE CONNECTOR FOR ELECTRICAL GROUND SWITCH

			Harting HAN® 24 DD	2	12	M25		SG325249R00521
								SG325249R00520

### MOBILE CONNECTOR FOR MACS ANALOGUE INPUT

MACS configurations		Mobile connectors					
Function	Analogue input source	Type	Female pins <sup>(4)</sup>		Cable gland	Cable entry	Secheron's reference
			Size	Qty			
PoW/Synchronous switching option	Sécheron TMS	Harting HAN® 3A	1.5 mm <sup>2</sup>	2	M20		SA016375R00001
	Voltage transformer						SA016375R00002
Overcurrent detection & tripping option	Sécheron TMS		1.5 mm <sup>2</sup>	2	M20		SA016375R00001
	Current transformer						SA016375R00002



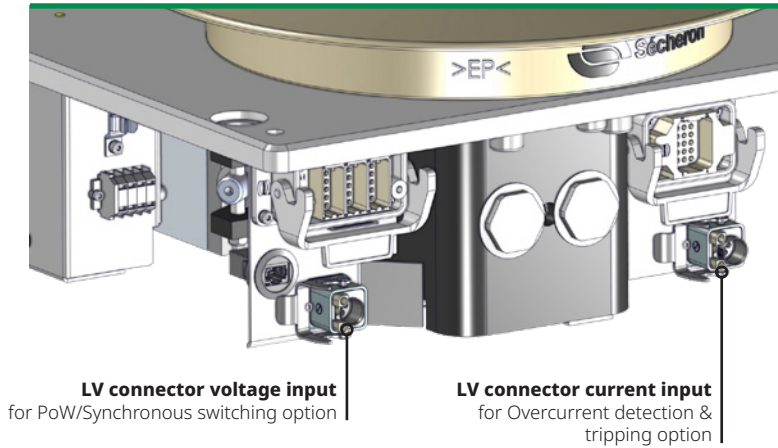











<sup>(4)</sup>An additional keying pin is delivered with the mobile connector's kit, which location on the connector will discriminate the connector for PoW/ synchronous switching function from the one for overcurrent detection & tripping function.

**Notes:**





- Harting Han® Modular 51-pin connector composed of 3 Harting HAN® DDD17 modules (each module supplied with 17 pins).
- The above references are given for mobile connectors assuming that all the auxiliary contacts are wired, with an external wire diameter of 2.8 mm for a 2.5 mm<sup>2</sup> conductor size and 2.3 mm for a 1.5 mm<sup>2</sup> conductor size. If the conditions differ from these, the above references may change. In this case, please inform Sécheron accordingly.

## LOW VOLTAGE MOBILE CONNECTOR ROOFBOX INSTALLATION (HARTING HAN® HPR 68-PINS CONNECTOR)

### MOBILE CONNECTOR FOR MACS AND OPTIONAL ELECTRICAL GROUND SWITCH

MACS configurations			Mobile connectors					
Auxilliary Switches			Type	Number of pin		Cable gland	Cable entry	Secheron's reference
Options	Manual ground switch	Auxiliary switches number		Size 2.5 mm <sup>2</sup>	Size 1.5 mm <sup>2</sup>			
None	No	4	Harting HAN® Modular 68 pins	-	23	M25		SG325649R00101
								SG325649R00201
2 Orders	Yes	4		-	32	M32		SG325649R00303
								SG325649R00403
Sync and/or OCP	No	4		-	32	M32		SG325649R00303
								SG325649R00403
None	Yes	8		-	44	M32		SG325649R00504
								SG325649R00604
eGS	No	4		-	44	M32		SG325649R00504
								SG325649R00604
Sync and/or OCP + eGS	Yes	4	-	44	M32		SG325649R00504	
							SG325649R00604	
eGS	No	8	-	55	2xM32		SG325649R00302	
Sync and/or OCP + eGS	No	6	-	55	2xM32		SG325649R00302	

### Low voltage connector for MACS Analogue Input

Sync or OCP			Han Shielded Power module	2	2	M32		SG325649R00701
								SG325649R00801
Sync & OCP				4	2	M32		SG325649R00702
								SG325649R00802

OCP: Overcurrent detection & tripping option

Sync: PoW/Synchronous switching option

# INTEGRATION OF MACS IN SECHERON AC HIGH VOLTAGE SYSTEMS

## AC MODBOX®

Car builders looking for solutions to protect roof-mounted high-voltage equipment from harsh environmental conditions, or wishing to reduce the aerodynamic drag of vehicles on their high-speed train platforms consider our **AC MODBOX®**.

The Sécheron AC MODBOX® compact metal enclosure ensures a safe and efficient integration of our AC circuit breakers and various high- and low-voltage components, among which the voltage sensor type TMS. AC MODBOX's designs are also available for installation inside the vehicle or under its chassis.

### Typical applications

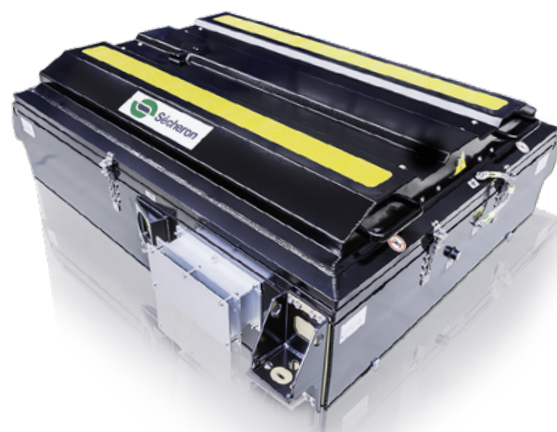
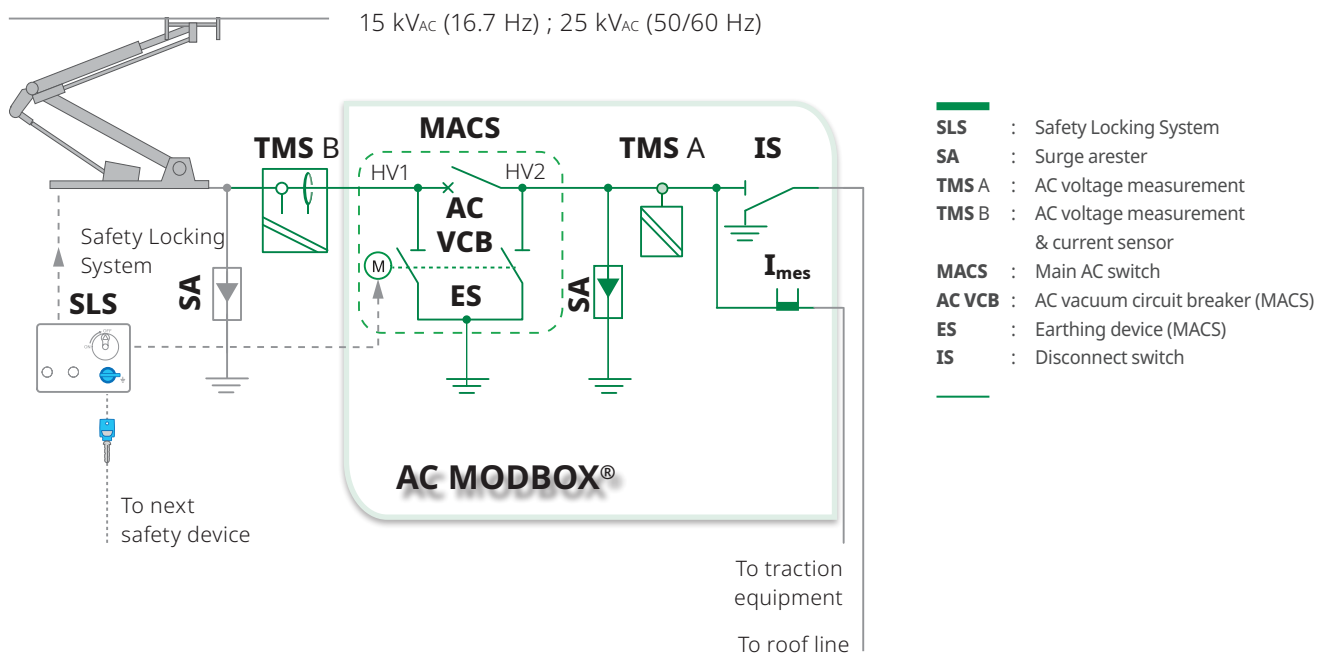

## AC MODFRAME

The **AC MODFRAME** is an integrated solution developed for open-air rooftop installation on AC and AC/DC Electrical Multiple Units (EMU). It integrates most of the high voltage roof components required for the operation and protection of AC rail vehicles on a single outdoor frame. The main components installed are from Sécheron's range, supplemented by other devices from leading third party suppliers. All components installed on the MODFRAME are

connected together with busbars, cables and braids, offering the car builder a simple and easy interface for high voltage connections between the MODFRAME and the vehicle. Low voltage cables are directly connected to the individual components through easily accessible outdoor type low voltage connectors. The installation of the MODFRAME on the roof does not require any roof cut-out except if the manual operation is selected for the earthing device.

### Typical applications

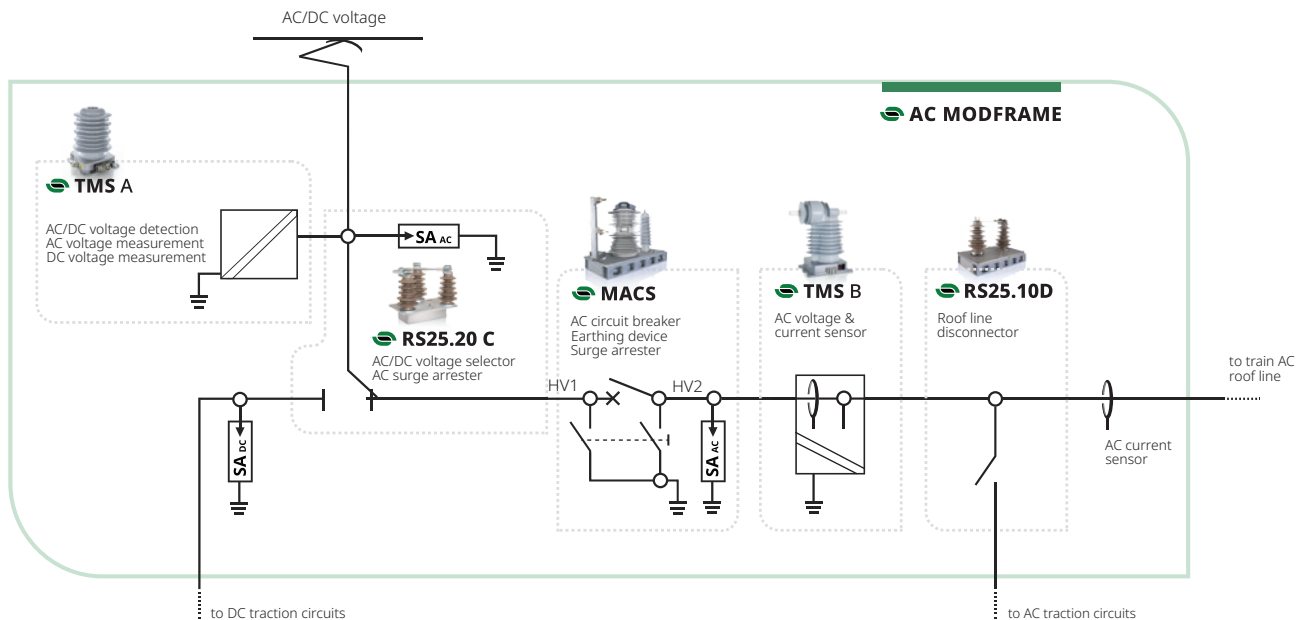

### AC MODFRAME

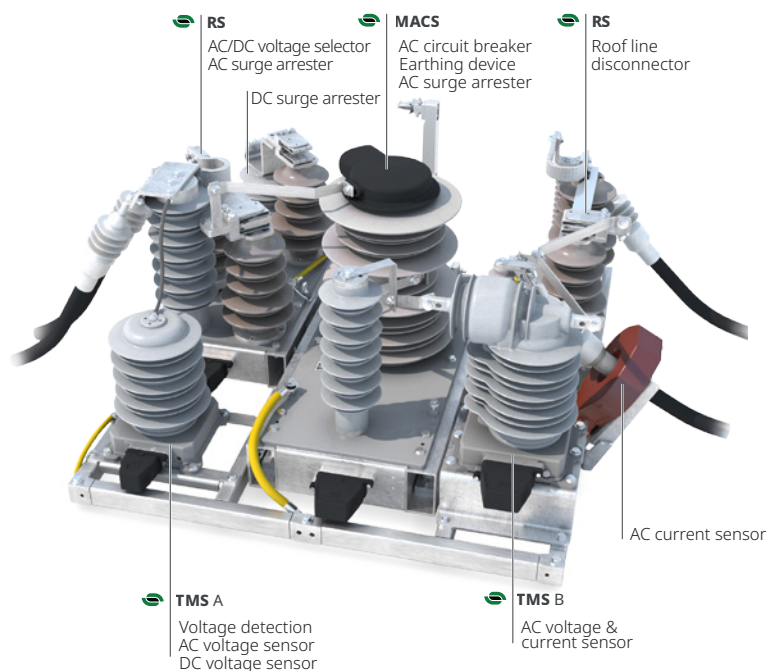

# DESIGNATION CODE FOR ORDERING

- Be sure to establish the designation code from the latest version of our brochure by downloading it from the website: [www.secheron.com](http://www.secheron.com)
- Be careful to write down the complete alphanumeric designation code with 12 characters when placing your order
- For technical reasons some variants and options indicated in the designation code might not be combined
- For other configurations not described in the brochure, please contact Sécheron.

## DESIGNATION CODE

<sup>(\*)</sup> Options are subject to additional costs

<b>Example of customer's choice:</b>	<b>M</b>	<b>7</b>	<b>A</b>	<b>1</b>	<b>∅</b>	<b>E</b>	<b>A</b>	<b>H</b>	<b>Z</b>	<b>Z</b>	<b>1</b>
Line:	10	11	12	13	14	15	16	17	18	19	20

Line	Description	Designation	standard	Options*	Customer's choice
10	Product type	<b>MACS</b>	<b>M</b>	<b>M</b>	<b>M</b>
11	Nominal Voltage & Insulation	15 kV or/and 25 kV (U <sub>Ni</sub> = 125 kV) 15 kV or/and 25 kV (U <sub>Ni</sub> = 170 kV) 25 kV - Harsh environment (U <sub>Ni</sub> = 185 kV)	7 6 5		
12	Mechanical interface	Standard base plate / vertical mounting Version for optional roof box <sup>(1)</sup>	A	F	
13	Earthing device (ES)	Yes (with manual operation) Yes (with electric operation)	1	2	
14	Integrated surge arrester (SA <sub>2</sub> )	No Yes - For surge arrester type and code, please contact Sécheron	∅	...	
15	Control voltage	24 V <sub>DC</sub> 32 V <sub>DC</sub> 36 V <sub>DC</sub> 48 V <sub>DC</sub> / 50 V <sub>DC</sub> 72 V <sub>DC</sub> 110 V <sub>DC</sub>	A B C D E	F	
16	Auxiliary contacts on the AC circuit breaker	4a + 4b - (switch PF) - silver type 4a + 4b - (switch PF) - gold type 6a + 6b - (switch PF) - silver type 6a + 6b - (switch PF) - gold type 8a + 8b - (switch PF) - silver type <sup>(2)</sup> 8a + 8b - (switch PF) - gold type <sup>(2)</sup>	A	C J G B D	
17	Auxiliary contacts on the earthing device	Not applicable <sup>(3)</sup> None 2a + 2b - (switch PF) - silver type 2a + 2b - (switch PF) - gold type	Z 0	H C	
18	Interlocking keys/locks for earthing device	(Electric operation) Not applicable None 1 blue (master) + 1 yellow (slave) 1 blue (master) + 2 yellow (slave) 2 blue (master) + 1 yellow (slave) 1 yellow (master) + 1 green (slave) 1 yellow (master) + 2 green (slave) 2 yellow (master) + 1 green (slave) Key / locks delivered by customer	Z 0	B C F H I L S	
19	Key and lock codification for each unit	(Electric operation) Not applicable No Yes	Z ∅	1	
20	Ambient temperature range	-40 °C to +70 °C -50 °C to +70 °C <sup>(4)</sup>	1	2	

<sup>(1)</sup> The roof box kit must be ordered separately. <sup>(2)</sup> If the synchronous switching option is selected the number of auxiliary switches is limited to 6 instead of 8 (4 as standard + 2 as option). <sup>(3)</sup> If no earthing device. <sup>(4)</sup> This option cannot be combined with synchronous switching or overcurrent detection and trip function.

Signature:

Name:

Place and date:

# PARAMETERS

In case you choose Synchronous switching and/or Overcurrent detection and trip function, Please fill the following form with your specifications for ordering. If any doubt please contact Sécheron.

## Synchronous switching

Synchronization parameters to be defined when ordering <sup>(5)</sup>

### Voltage sensor type

TMS (with bipolar output) or  Transformer type  
Transformer ratio: \_\_\_ : \_\_\_

### Catenary supply voltage

A 25 kV (50 Hz)  B 15 kV (16.7 Hz)  
 C 25 kV (50 Hz) & 15 kV (16.7 Hz) <sup>(6)</sup>  D 25 kV (60 Hz)  
 E 12 kV (25 Hz)

### Synchronization parameters

#### Neutral section

Opening phase ( $\Phi_{open}$ ) \_\_\_\_\_ Closing phase ( $\Phi_{close}$ ) \_\_\_\_\_

#### Other events

Closing after vehicle's power up ( $\Phi_{PwrUp}$ ) \_\_\_\_\_ Closing after trip orders through order 1 ( $\Phi_{EMOpen}$ ) \_\_\_\_\_

## Overcurrent detection and trip function

### Trip thresholds for MACS in CLOSED position:

for overcurrent ( $I_{rms\_cl}$ ) \_\_\_\_\_ A(rms) for short-circuit ( $I_{sc\_cl}$ ) \_\_\_\_\_ A(peak)

### Trip thresholds for MACS in OPEN position:

for overcurrent ( $I_{rms\_op}$ ) \_\_\_\_\_ A(rms) for short-circuit ( $I_{sc\_op}$ ) \_\_\_\_\_ A(peak)

### Reclosing delay after tripping:

on overcurrent \_\_\_\_\_ ms

### Current transformer ratio:

( $N_{ocp}$ ) \_\_\_\_\_ : \_\_\_\_\_

<sup>(5)</sup> Check that the transformer ratio is compatible with voltage input range indicated on page 13.

<sup>(6)</sup> For multi-catenary voltage supply applications, times  $t_a$ ,  $t_p$  and  $t_d$  can be adjusted. Refer to instructions manual.

# MATERIAL TO BE ORDERED ADDITIONALLY TO THE MACS

## THROUGH ROOF

### LV mobile connector for the AC circuit breaker

SG325249R00 \_\_\_ \_\_\_ \_\_\_

select the last 3 digits in the table page 15 function of your selection

### Additional LV mobile connector for the electric earthing device

SG325249R00521  SG325249R00520

### Additional LV mobile connector for voltage analog input

(only in case synchronous switching option is selected)

SA016375R00001  SA016375R00002

### Additional LV mobile connector for current analog input

(only in case overcurrent detection and tripping option is selected)

SA016375R00001  SA016375R00002

## ROOFBOX

### Main LV mobile connector

SG325649R00 \_\_\_ \_\_\_ \_\_\_

select the last 3 digits in the table page 16 function of your selection

### Additional LV mobile connector for analog signals

SG325649R00 \_\_\_ \_\_\_ \_\_\_

The low voltage connector must be ordered separately (refer to page 15 & 16).



### Sécheron SA

Rue du Pré-Bouvier 25  
1242 Satigny - Geneva  
CH-Switzerland

### www.secheron.com

Tel: +41 22 739 41 11  
Fax: +41 22 739 48 11  
ess@secheron.com

Signature:

Name:

Place and date: