

SUPPLY PROGRAM

FOR FIXED INSTALLATION



OUR VALUE PROPOSITION FOR
**FIXED INSTALLATION
 SOLUTIONS**

- Wide range of solutions for electrical switching and protection
- Standard product portfolio or customized solutions
- In-house key capabilities to address our business
- Accreditation of Sécheron's internal laboratories for railway electrotechnical components
- Decades of successful experience with our equipment around the world

APPLICATIONS		Pages
	Overview of high power DC equipment for Medium Voltage AC & DC Grids	4 - 5
INFRASTRUCTURE FOR SUSTAINABLE MOBILITY		
	DC traction power substations for rail transportation	6
	DC traction power substations for mines with electric trucks	7
	Fast & ultra-fast charging stations for battery powered vehicles	8
RENEWABLE ENERGY PRODUCTION & STORAGE		
	Static excitation systems for power plants	9
	Fusion power demonstrators	10
	Solar farms	11
	Battery Energy Storage Systems	12
ENERGY INTENSIVE INDUSTRIES		
	Hydrogen production plants	13
	Industries using high power DC motors	14
	Data centers with DC power distribution	15
PRODUCTS		
DC circuit breakers	High power DC circuit breakers	UR 16
Contactors	High power DC contactors	BMS, SEC, HS 17
Off-load switches	Disconnectors for traction substations	SW 18
SERVICES		
		19

OVERVIEW OF SECHERON'S SAFETY & SWITCHING COMPONENTS FOR FIXED INSTALLATIONS

PRODUCT RANGES

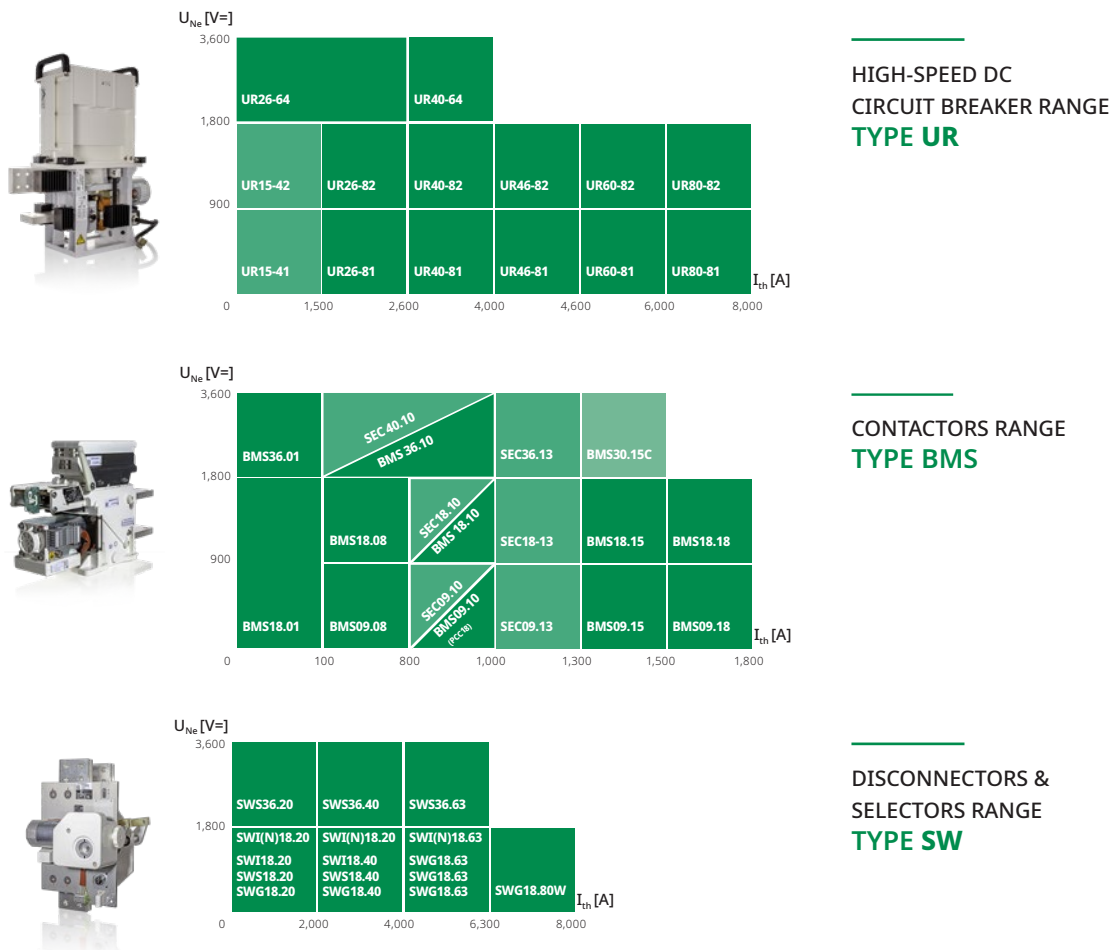

MAIN BENEFITS

- ✓ Strong and deep expertise in DC medium voltage safety and switching components
- ✓ Strong testing culture at all levels to bring reliable and proven solutions to the market
- ✓ Continuous increase of the added value of our products & solutions through innovation
- ✓ Standard and customized products/solutions
- ✓ Strong and expert teams to support clients during all phases of their project
- ✓ Large installed base of products in operation worldwide
- ✓ Large worldwide sales & service network

APPLICATIONS

OVERVIEW OF HIGH POWER DC EQUIPMENT FOR MEDIUM VOLTAGE AC GRID

FROM CLEAN ENERGY SOURCES TO DC INDUSTRIES AND TRANSPORTATION

SÉCHERON SCOPE SUPPLY

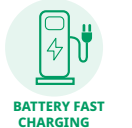
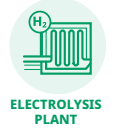
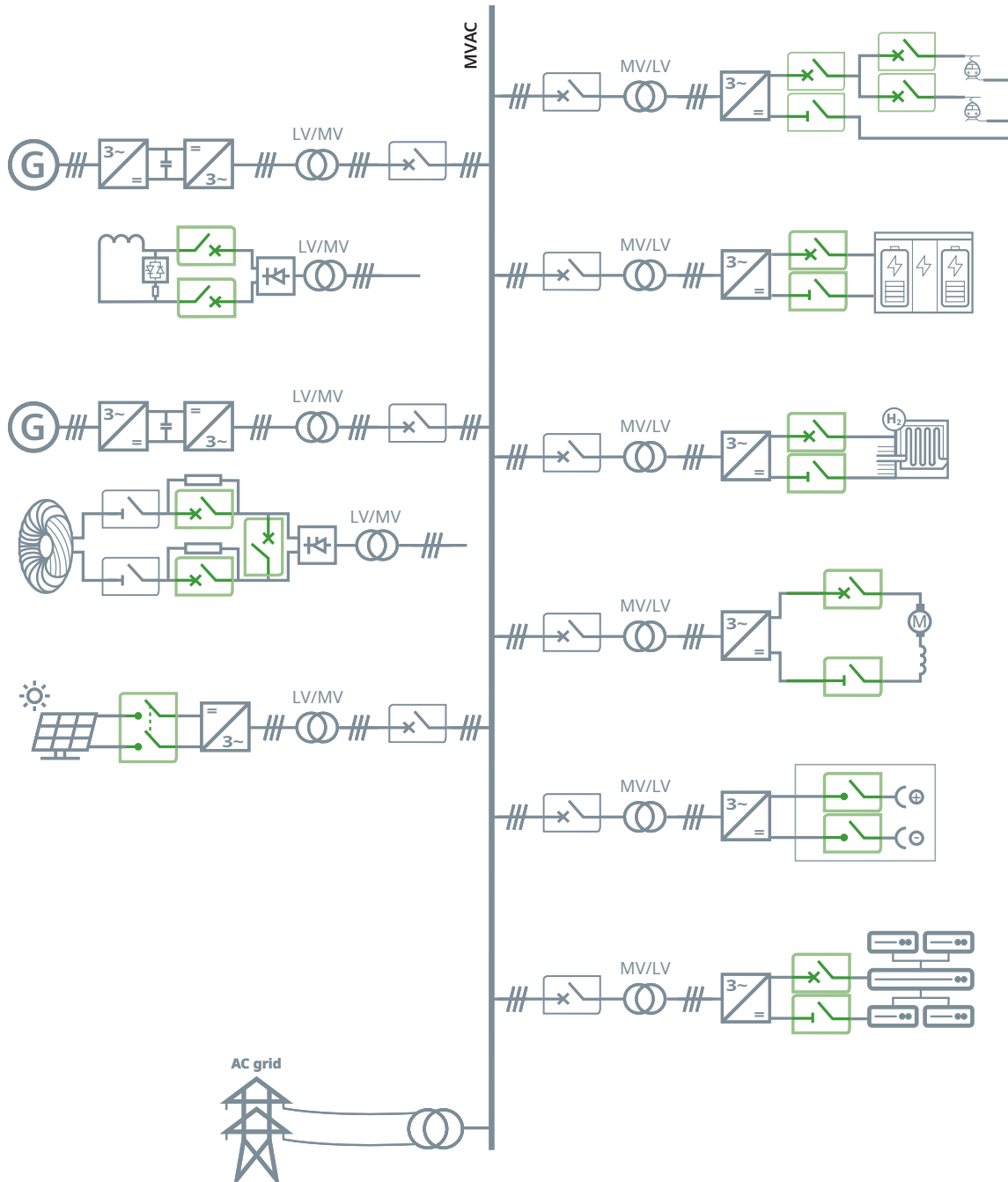
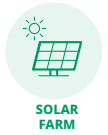

OVERVIEW OF HIGH POWER DC EQUIPMENT FOR MEDIUM VOLTAGE DC GRID

FUTURE DEVELOPMENT OF MVDC GRIDS TO BRING MULTIPLE BENEFITS

SÉCHERON SCOPE SUPPLY



CONTACTOR



HIGH-SPEED DC CIRCUIT BREAKER



DISCONNECTER

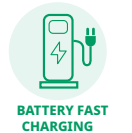
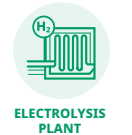
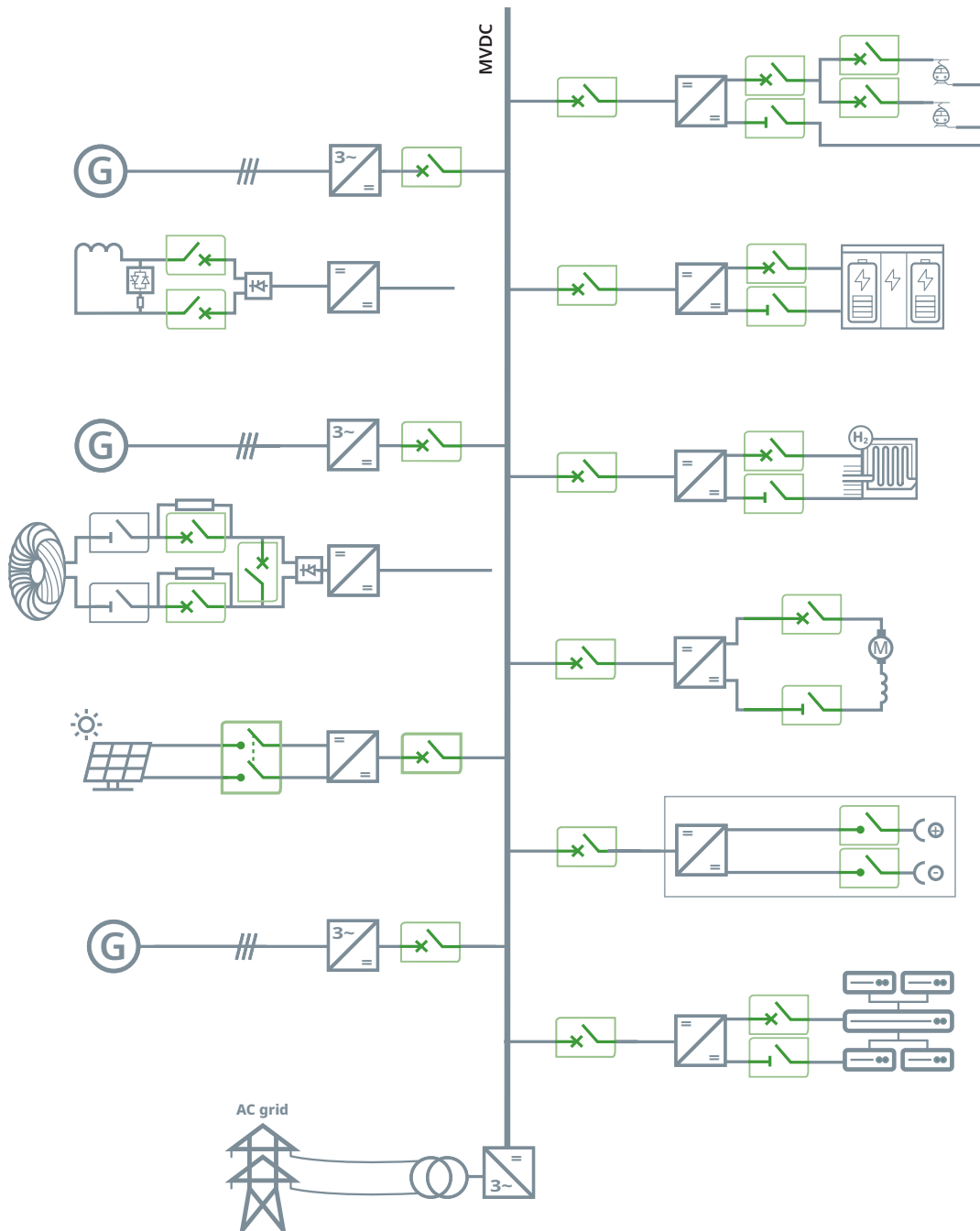
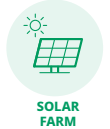



DC TRACTION POWER SUBSTATIONS FOR RAIL TRANSPORTATION

KEY POINTS OF THE APPLICATION

- High-speed current limiting DC circuit breaker.
- Reference standards EN 50123-2/IEC 61992 and IEEE C37.14 (USA).
- Bi-directional DC circuit breaker very efficient for both resistive and highly inductive short-circuits.
- maximum safety with opening in the event of loss of auxiliary power, and bistable version for traffic priority
- Proven design with an impressive track record around the world.

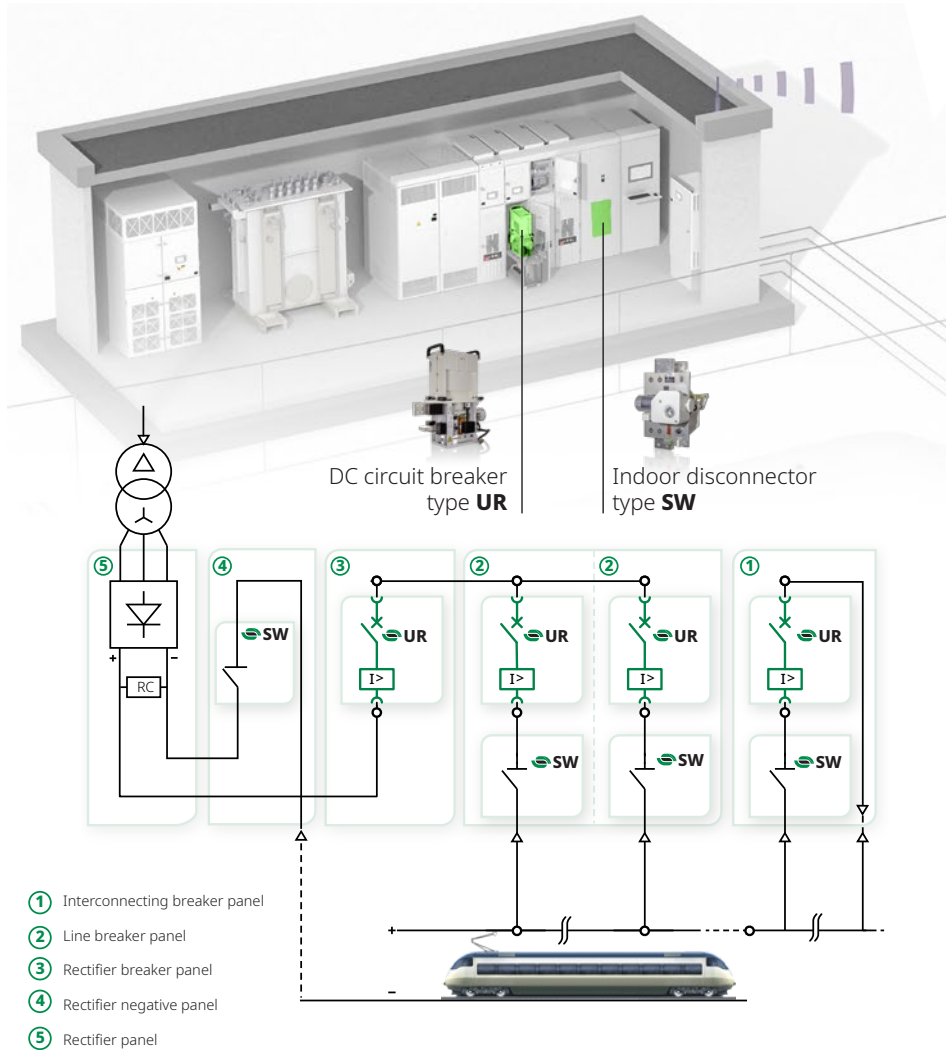

TYPICAL TRACTION SUBSTATION FOR DC RAILWAY NETWORK

PRODUCT RANGES

HIGH-SPEED DC CIRCUIT BREAKER RANGE TYPE UR

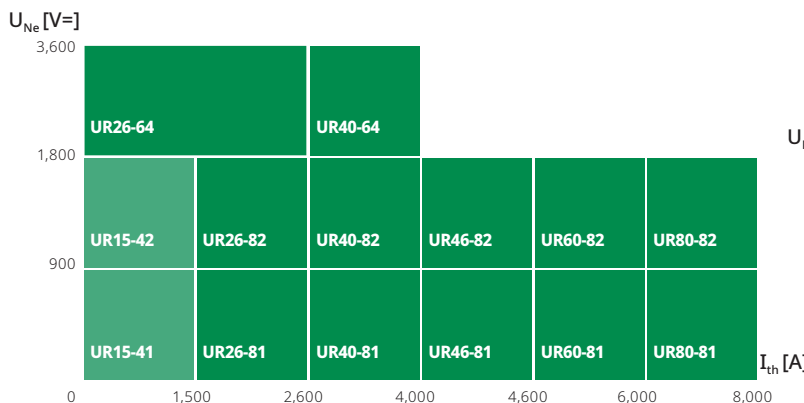

DISCONNECTORS & SELECTORS RANGE TYPE SW

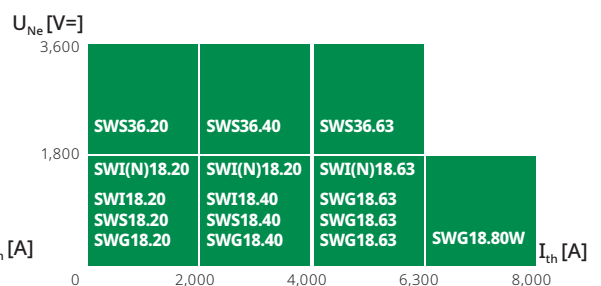



DC TRACTION POWER SUBSTATIONS FOR MINES WITH ELECTRIC TRUCKS

KEY POINTS OF THE APPLICATION

- High-speed current limiting DC circuit breaker.
- Reference standards EN 50123-2/IEC 61992 and IEEE C37.14 (USA).
- Bi-directional DC circuit breaker very efficient for both resistive and highly inductive short-circuits.
- maximum safety with opening in the event of loss of auxiliary power, and bistable version for traffic priority
- Proven design with an impressive track record around the world.

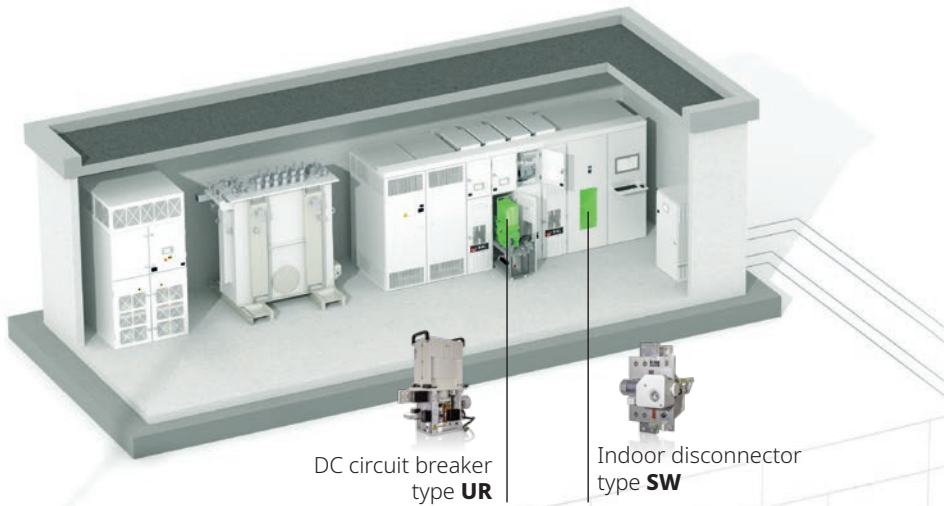

DC circuit breaker type **UR**

Indoor disconnector type **SW**

TYPICAL TRACTION SUBSTATION FOR DC NETWORK



PRODUCT RANGES

HIGH-SPEED DC CIRCUIT BREAKER RANGE TYPE UR

U_{Ne} [V=]	3,600	UR26-64		UR40-64						
	1,800	UR15-42	UR26-82	UR40-82	UR46-82	UR60-82	UR80-82			
	900	UR15-41	UR26-81	UR40-81	UR46-81	UR60-81	UR80-81			
		0	1,500	2,600	4,000	4,600	6,000	8,000	I_{th} [A]	

DISCONNECTORS & SELECTORS RANGE TYPE SW

U_{Ne} [V=]	3,600	SWS36.20		SWS36.40	SWS36.63						
	1,800	SWI(N)18.20		SWI(N)18.20	SWI(N)18.63						
		SWI18.20	SWS18.20	SWG18.20	SWI18.40	SWS18.40	SWG18.40	SWI18.63	SWS18.63	SWG18.63	SWG18.80W
		0	2,000	4,000	6,300	8,000	I_{th} [A]				



FAST & ULTRA-FAST CHARGING STATIONS FOR BATTERY POWERED VEHICLES



TYPICAL SCHEME OF ULTRA-FAST CHARGING STATION

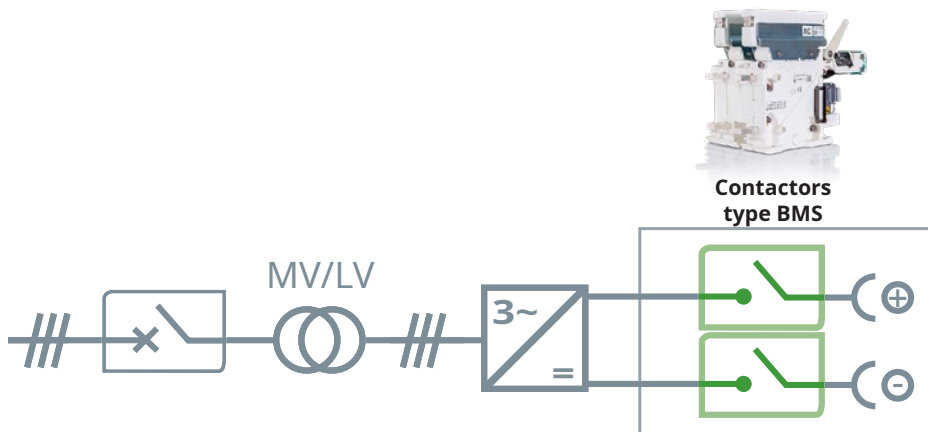

KEY POINTS OF THE APPLICATION

- Today ultra-fast charging stations are limited to 600 kW.
- With the soon coming super-fast Megawatt Charging System (MCS), the maximum charging rate is expected to grow up to 3.75 Megawatts (3,000 A at 1,250 V_{DC}).
- Double-poles, bidirectional high power contactors.
- High peak current during a very short time in case of failure.
- Technology with a large installed basis worldwide.

PRODUCT RANGES

CONTACTORS RANGE TYPE BMS

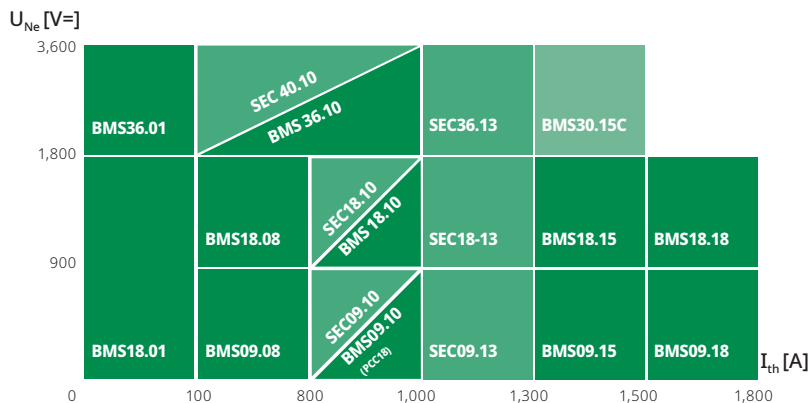



STATIC EXCITATION SYSTEMS FOR POWER PLANTS



TYPICAL EXCITATION SYSTEM FOR A POWER GENERATION TURBINE

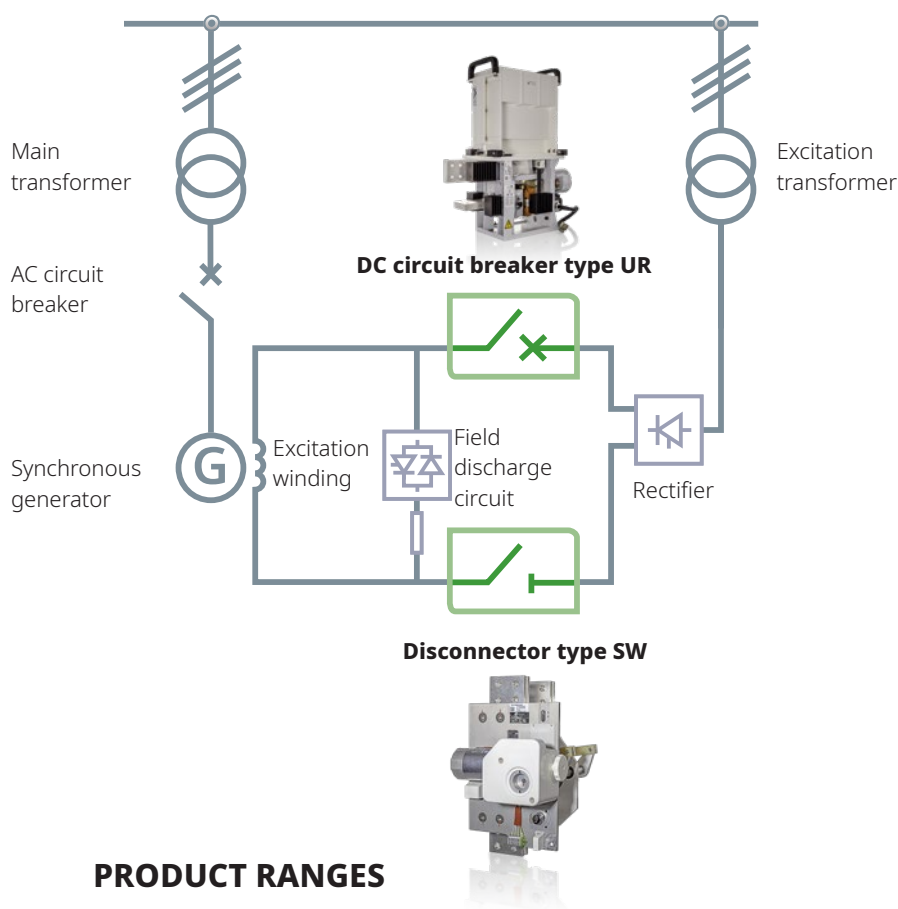

KEY POINTS OF THE APPLICATION

- Opening of the DC breaker only in case of fault conditions on generator or excitation side.
- Generation of sufficient overvoltage by the DC breaker for a rapid switching of energy from the excitation winding to the discharge circuit.
- In case of short-circuit in the field circuit, the DC breaker limits and interrupts the fault current
- The disconnector isolates the rectifier negative pole for maintenance operations.

PRODUCT RANGES

HIGH-SPEED DC CIRCUIT BREAKER RANGE TYPE UR

U_{Ne} [V=]	1,500		2,600		4,000		4,600		6,000		8,000	
3,600	UR26-64		UR40-64									
1,800	UR15-42	UR26-82	UR40-82	UR46-82	UR60-82	UR80-82						
900	UR15-41	UR26-81	UR40-81	UR46-81	UR60-81	UR80-81						

DISCONNECTORS & SELECTORS RANGE TYPE SW

U_{Ne} [V=]	2,000		4,000		6,300		8,000	
3,600	SWS36.20		SWS36.40		SWS36.63			
1,800	SWI(N)18.20	SWI(N)18.20	SWI(N)18.63					
	SWG18.20	SWG18.40	SWG18.63	SWG18.63	SWG18.63	SWG18.80W		



FUSION POWER DEMONSTRATORS



**HIGH POWER SWITCH
FOR MAGNET POWER
SUPPLY**

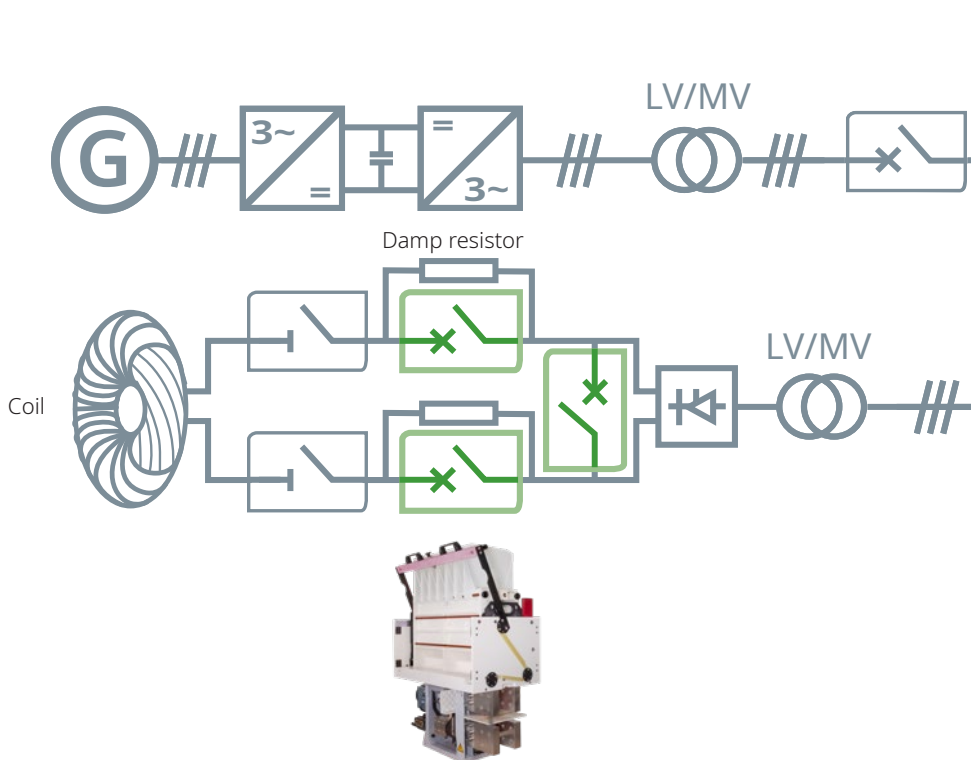

DC circuit breaker type UR

KEY POINTS OF THE APPLICATION

- DC circuit breaker opens only to isolate the coil in the event of a fault.
- After the converter has been blocked, the energy stored in the coil is dissipated through the damp resistors.
- The main function of the DC circuit breaker is to quickly switch high currents of the coil into the damp resistors.
- During the arcing process, the DC breaker forces the current to flow into the damp resistors, until the current reaches zero.

PRODUCT RANGES

HIGH-SPEED DC CIRCUIT BREAKER RANGE
TYPE UR

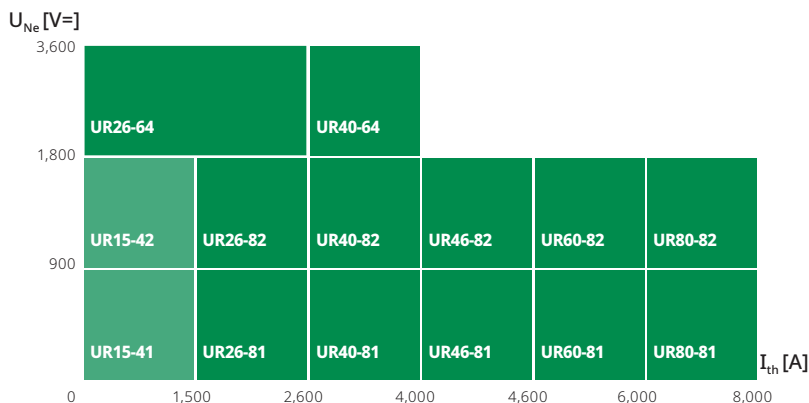



SOLAR FARMS



TYPICAL EXCITATION SYSTEM FOR A POWER GENERATION TURBINE

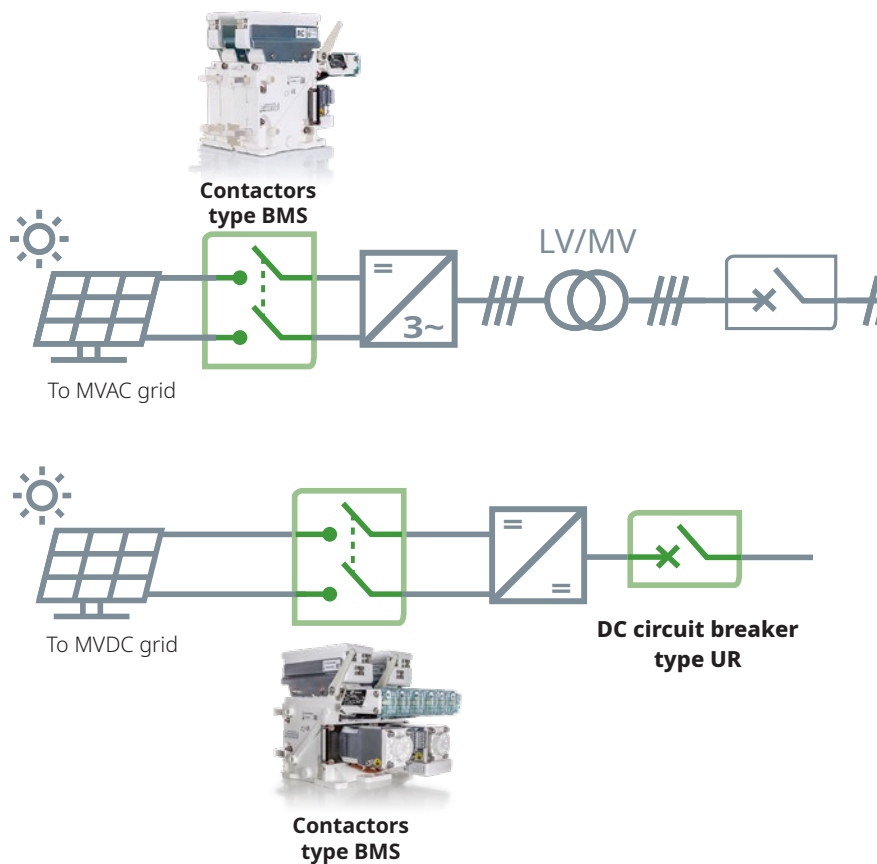

KEY POINTS OF THE APPLICATION

- Bipolar contactor to connect/isolate central or string inverters.
- Rated voltage up to 1,500 V_{DC} with current from 400 to 3,200 A.
- Making and breaking of ohmic loads
- High peak current during a very short time in case of fault conditions.

PRODUCT RANGES

CONTACTORS RANGE TYPE BMS

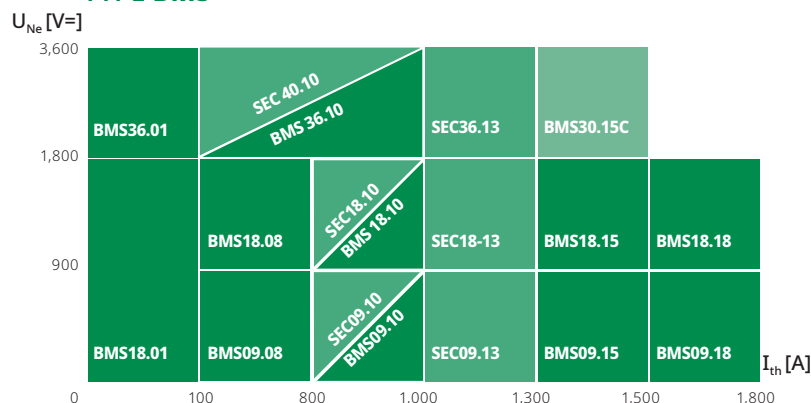



BATTERY ENERGY STORAGE SYSTEMS



TYPICAL SCHEME OF BATTERY ENERGY STORAGE SYSTEM

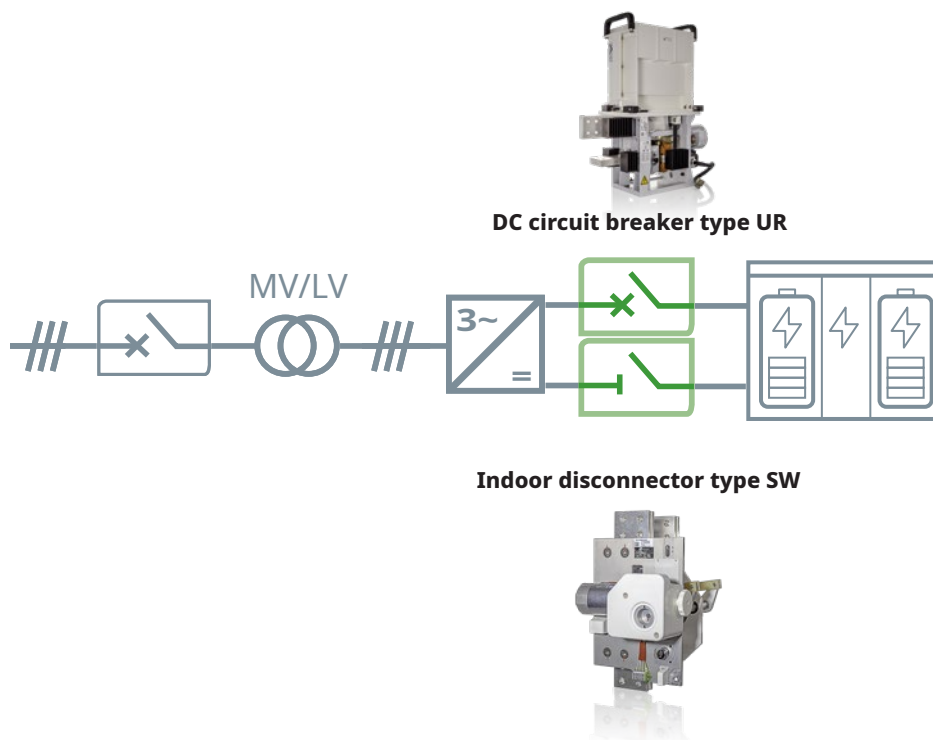

KEY POINTS OF THE APPLICATION

- Use of bipolar contactor or DC breaker and disconnecter.
- Bi-directional unit with ohmic load interruptions and high peak current in case of fault conditions.
- Rated voltage up to 1,500 V_{DC} with current from up to 6,000 A.

PRODUCT RANGES

HIGH-SPEED DC CIRCUIT BREAKER RANGE TYPE UR

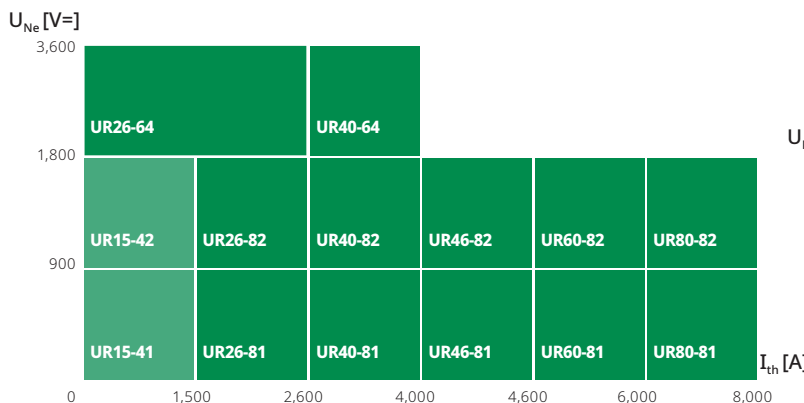

DISCONNECTORS & SELECTORS RANGE TYPE SW

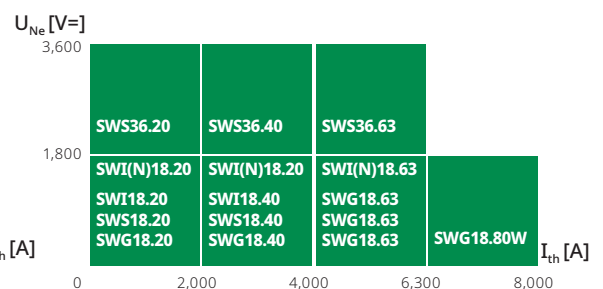



HYDROGEN PRODUCTION PLANTS



TYPICAL EXAMPLE OF DC PROTECTION IN H₂ PRODUCTION PLANT

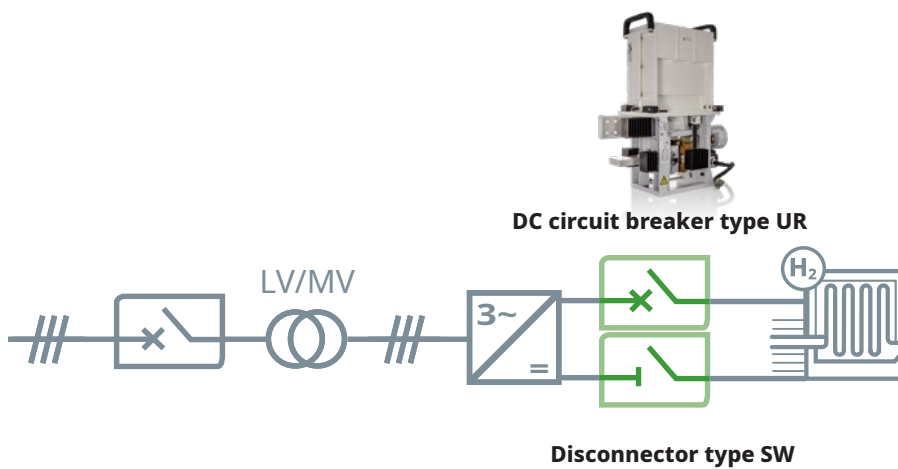

KEY POINTS OF THE APPLICATION

- To optimize your system's uptime, protect electrolyzers with DC circuit breakers and disconnectors.
- High-speed DC circuit breaker with high breaking capacity.
- Wide product ranges for current up to 8,000 A and voltage up to 3.6 kV_{DC}.
- Market well proven technology with a large installed basis worldwide.

PRODUCT RANGES

HIGH-SPEED DC CIRCUIT BREAKER RANGE TYPE UR

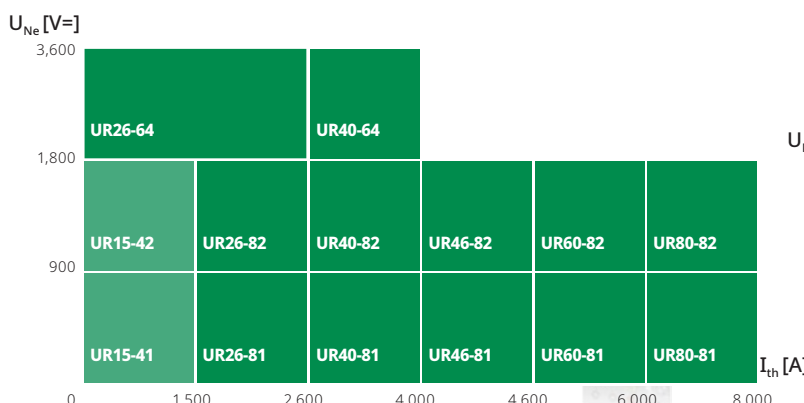

DISCONNECTORS & SELECTORS RANGE TYPE SW

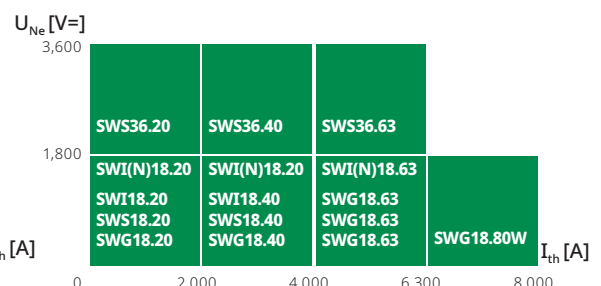



INDUSTRIES USING HIGH POWER DC MOTORS



TYPICAL PROTECTION SCHEME FOR DC MOTOR

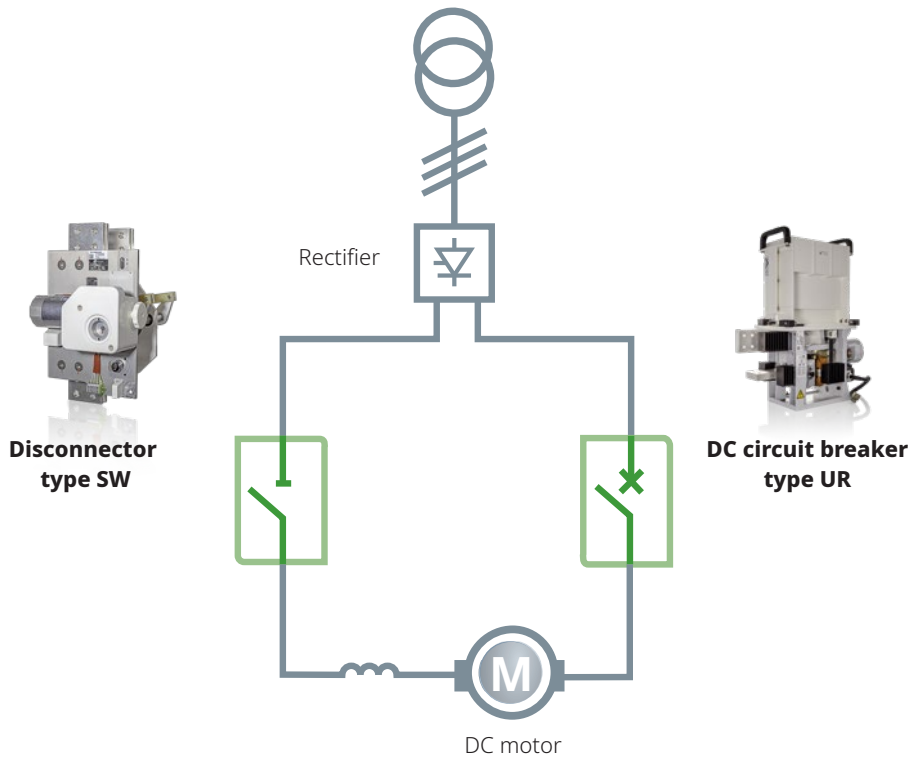

Disconnector type SW

DC circuit breaker type UR

KEY POINTS OF THE APPLICATION

- DC circuit breaker protects the armature of the DC machine against overloads and short-circuits.
- Downtime of the production equipment minimized in case of failure or during maintenance operation. Production equipment operated 24/7.
- Equipment reliability is a key factor in maximizing production output.
- DC breaker's requirements include fast tripping, high breaking capacity, high mechanical and electrical endurance, very low maintenance.
- Applicable also to rolling mills, hoists machine, grinding mills and others.

PRODUCT RANGES

HIGH-SPEED DC CIRCUIT BREAKER RANGE TYPE UR

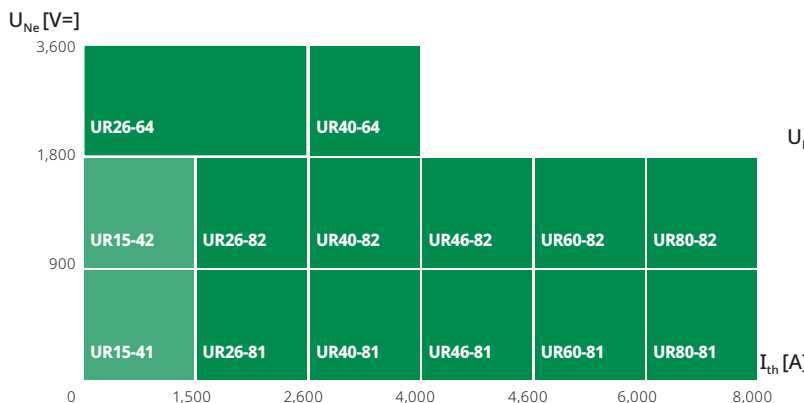

DISCONNECTORS & SELECTORS RANGE TYPE SW

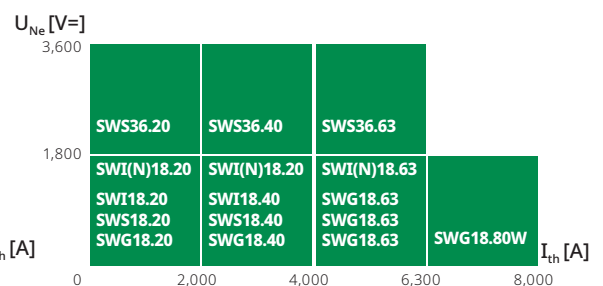



DATA CENTERS WITH DC POWER DISTRIBUTION



**DATA CENTERS
WITH DC POWER
DISTRIBUTION**

KEY POINTS OF THE APPLICATION

- AC current is used for the power distribution in the today's typical Data Centers.
- DC power data centers represent a great potential for the future for the benefits they offer.
- Significant savings on operating (less heat dissipation and cooling) and maintenance costs.
- Reduced physical space with elimination of AC/DC power conversion.
- Sécheron DC switching and protection components will support the development of DC power data centers.

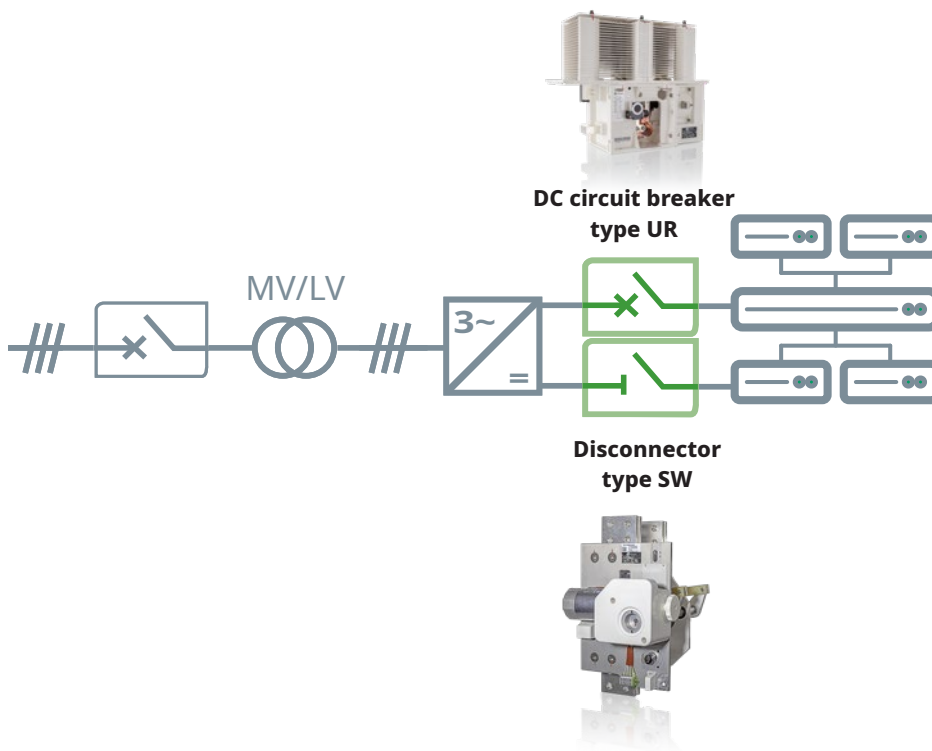

PRODUCT RANGES

HIGH-SPEED DC CIRCUIT BREAKER RANGE TYPE UR

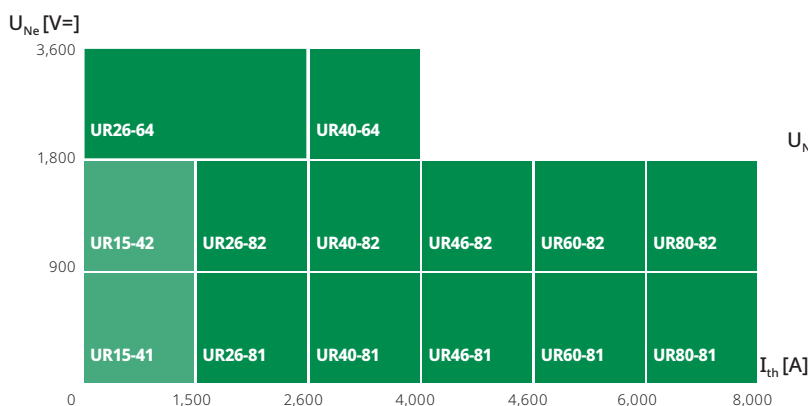

DISCONNECTORS & SELECTORS RANGE TYPE SW

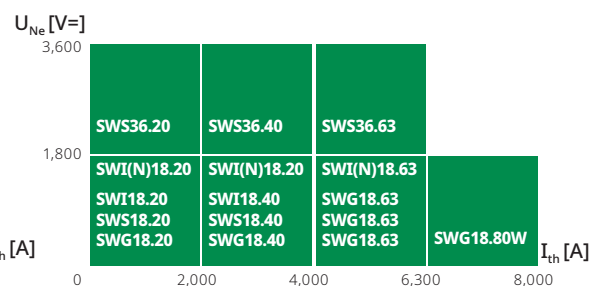

PRODUCTS

HIGH-SPEED DC CIRCUIT BREAKERS

UR type



Brochure UR26-80S IEC

Brochure UR26-80S ANSI

For DC applications, Sécheron proposes a complete range of high-speed current limiting circuit-breakers rated up to 8,000 A and up to 3,600 Vdc. These DC circuit-breakers are used in various applications to protect equipment against short-circuit currents and overloads.

The DC circuit-breakers UR range has achieved worldwide acceptance as a well proven design for use in fixed installations. The complete range has been regularly upgraded and adapted to new standard requirements and for different applications over the years, continuously improving the level of performance and functionality. These have led to an impressive service track record throughout the world for the UR product range.

Combining a compact design with a high making and breaking capacity, the UR range, with its low number of parts also guarantees high reliability and low maintenance requirements.



Product range

**IEEE / EN /
ANSI IEC**

U [V=]

3,600	UR26-64		UR40-64					
1,800		(1)	(1)	(1)	(1)	(1)	(1)	
900	UR15-42	UR26-82	UR40-82	UR46-82	UR60-82	UR80-82		
0	UR15-41	UR26-81	UR40-81	UR46-81	UR60-81	UR80-81		
0	0	1,500	2,600	4,000	4,600	6,000	8,000	I [A]
	0	0	2,150	3,200	4,000	6,000	8,000	

Standards

EN 50123 / EC 61992
IEEE / ANSI

All breakers are compliant to EN/IEC Standards

(1) DC circuit breakers also IEEE / ANSI compliant

AC/DC POWER & AUXILIARY CONTACTORS

/// BMS, SEC type



Brochure BMS..08_BMS..10
Brochure BMS..15_BMS..18
Brochure SEC

Sécheron brings decades of experience designing and manufacturing power contactor solutions for the railway industry as well as for energy intensive industries or renewable energy industries.

Power converter manufacturers, count on our contactor solutions for reliable performance.

Our BMS, SEC, and HS contactors can be configured to meet a wide variety of needs, including converter switches or permanent-magnet synchronous motor (PMSM) switches.

Our contactors can be delivered on a stand-alone basis or in modules you can integrate into your own equipment.



Standard
EN/IEC60077

U [V= / V~]

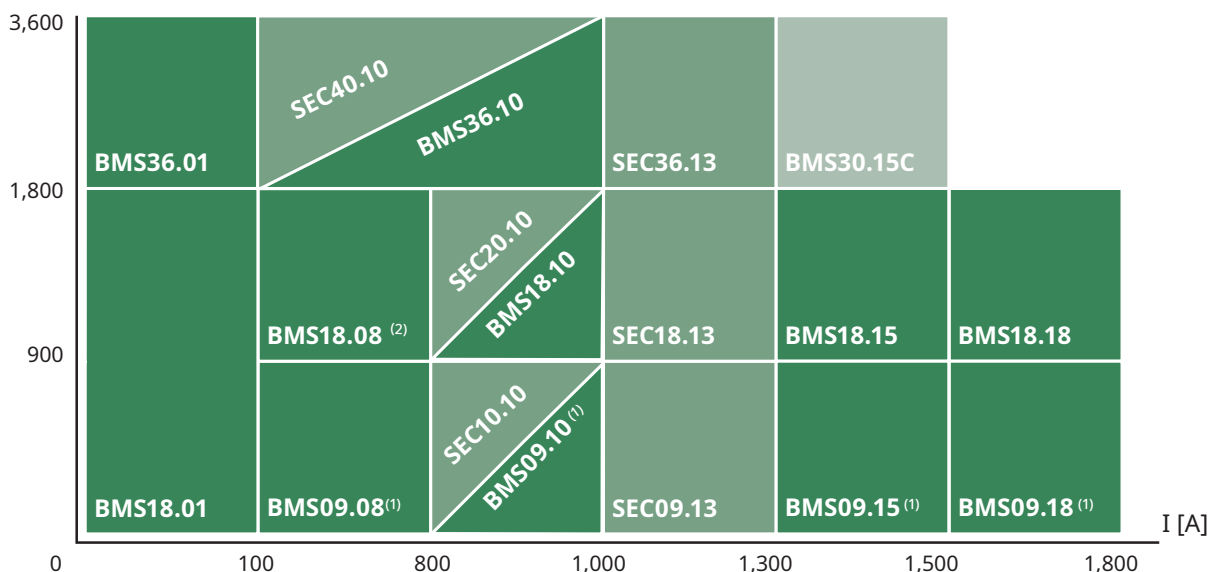

⁽¹⁾ BMS09... can be used for rated voltages up to 2,000 V_{AC}

⁽²⁾ A specific version of BMS18.08 can also be used for rated voltage up to 4,000 V_{AC}

DISCONNECTORS

SW type

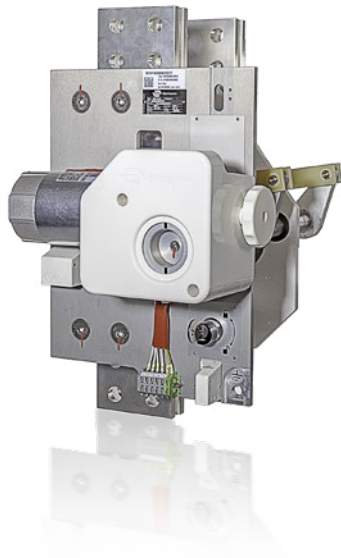

Sécheron brings decades of experience designing and manufacturing electrical safety components and solutions for DC power substations.

Our **SW**-type off-load disconnect switch comes in a wide range of configurations and with optional features to meet the needs of all applications. Our switches ensure the safe isolation of the equipment from the power supply.

Our disconnectors for fixed installations can be integrated into your disconnecter panels to be used as converter, by-pass disconnecter, or as the disconnecter and earthing switch.



[Brochure SW](#)

Product range

Functional scope

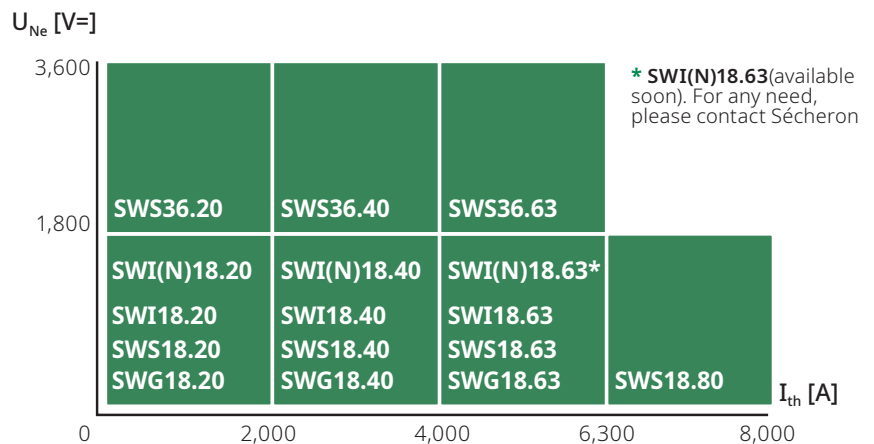
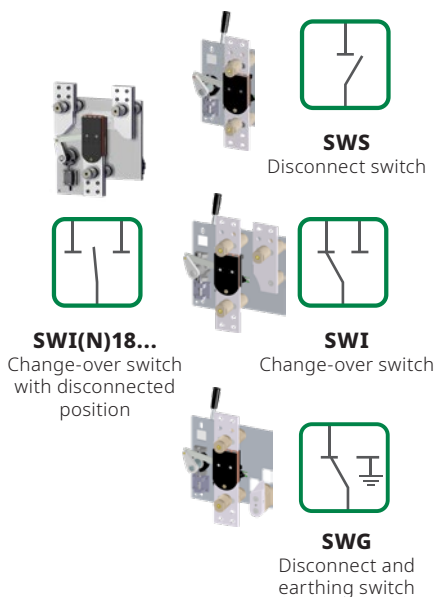

All products available in 1- & 2-poles, except SWI/SWG18.63, SWS18.80, SWI(N) available only in 1-pole

SERVICES

Project management

Efficient teams, including Project Managers and Technical Specialists, support our customers throughout their projects and help them to select the most appropriate solutions within our standard product platforms, or propose customized products and complete integrated solutions for their applications.



Engineering support

Sécheron has developed unique core competences related to its activity and can provide our customers with high-value engineering services to support their projects.

The Computer Aided Engineering (CAE) multi-physics tool allows our experts to analyze, simulate and optimize the products and solutions we design, while reducing the technical risks and shortening development times and test cycles.

One of the things that makes us unique is our broad, deep knowledge of testing methods and our in-house testing labs and equipment. Our capabilities include: temperature-rise testing, dielectric and partial discharge measurements, complete electrical and mechanical endurance tests, short-circuit and low-current interruptions, vibration and shock tests, and functional and climate tests. Most of our testing facilities are ISO 17025-accredited as independent laboratories.



Documentation

Documentation to be delivered at different stages of a project has currently become more diversified and more substantial. It is also a key issue for our customers.

Here again, our team of specialists works to prepare and promptly provide customers with detailed Maintenance & Operations manuals, RAMS analysis, product material lists, type test certificates, fire & smoke certificates, structural simulations, when necessary, and all other useful documents.



After sales service

The strategy of Sécheron SA is to provide our customers with strong support and dedicated services throughout all equipment purchase and installation phases, as well as during the lifetime of the material once it enters service. To satisfy this commitment, Sécheron has set up a worldwide network of over 40 Sales and Service Points which enable our customers to find local support, whenever possible, and thus be able to address their requests in the most efficient way. The After sales service, provided on a global or local basis, covers at least the following requirements: Preventive maintenance and repair, E-learning & Training and retrofit & modernization project.



Sécheron original parts

In order to guarantee the reliability and the performance of Sécheron's safety devices, only Sécheron's original spare parts must be used through the complete product lifetime. These original parts, manufactured and checked following rigorous processes, are now stamped with the Sécheron's logo and the traceability number, either on the parts themselves or on their original packaging.



Contact Sécheron or our official partners (www.secheron.com/worldwide/) to be supplied with guaranteed original parts.

SÉCHERON'S WORLDWIDE NETWORK

HEAD OFFICE

📍 Sécheron SA (Switzerland)

Switzerland & rest of the world

Rue du Pré-Bouvier 25
1242 Satigny - Geneva - Switzerland
+41 22 739 41 11 | ess@secheron.com

SALES OFFICES

EUROPE

📍 Sécheron Hasler CZ, spol. s r.o.

Czech Republic, Slovakia,

Podnikatelská 556
190 11 Praha 9 - Běchovice Czech Republic
+420 271 088 111 | ess@secheron.com

📍 Sécheron Hasler GmbH

Germany, Austria, Netherlands

Max-Holder-Straße 41
60437 Frankfurt am Main - Germany
+49 695 06086 130 | ess.germany@secheron.com

📍 Sécheron Hasler Ibérica, S.L.

Spain, Portugal, Andorra

Calle Calidad 42 - Polígono Industrial Los Olivos
28906 Getafe - Madrid - Spain
+34 91 620 79 58 | ess.spain@secheron.com

📍 Sécheron Hasler Italia S.r.l.

Italy, Malta

Linate Business Park, Via Rivoltana 35
20096 Piolto - MI - Italy
+39 02 92162 590 | ess.italy@secheron.com

📍 Sécheron Hasler UK Ltd.

Great Britain, Ireland

Unit A2, Brookside Business Park, Greengate,
Middleton - M24 1GS Manchester - United Kingdom
+44 161 655 6610 | ess.uk@secheron.com

📍 Sécheron, Sales office Poland

Poland

+48 533 966 939 | ess.poland@secheron.com

ASIA

📍 Sécheron (China) Co. Ltd.

China

Section B, 1F Building 1, 111 Shennan Road,
Xinzhuang Industrial Park - 201108 Shanghai - China
+86 21 6442 2900 | ess.china@secheron.com

📍 Sécheron Hasler (India) Private Ltd.

India, Bangladesh, Nepal, Pakistan, Sri Lanka

17-C, Udyog Vihar, Phase V.
Gurgaon 122 016 - India
+91 124 4141 714 | ess.india@secheron.com

📍 Sécheron Hasler Japan Co. Ltd

Japan

4004-6, Kamimizo, Chuo-ku, Sagamihara-city -
252-0243, kanagawa - Japan
+81 80 5890 3732 | ess.japan@secheron.com

AMERICAS

📍 Sécheron Hasler do Brasil

Brazil

Rua João Anes, 90
05060-020 Alto da Lapa - São Paulo - SP - Brazil
+55 11 3714 6026 | ess.brazil@secheron.com

📍 Sécheron Hasler USA Inc.

USA

600 North Bell Avenue, Building 1, Suite 110
Carnegie - PA 15106 - United States of America
+1 412 505 5545 | ess.usa@secheron.com

SELLING PARTNERS

Find out our partners selling Sécheron's products on our website! www.secheron.com/worldwide/



www.secheron.com

Copyright © • 2023 • Sécheron SA

This document is not contractual and contains information corresponding to the level of technology at the date of printing. Sécheron reserves the right to modify and/or improve the product, whose characteristics are described in this document, as required by new technology at any time. It is the purchaser's responsibility to inform himself, no matter what the circumstances, of the product's maintenance conditions and requirements. Sécheron reserves all rights, especially those arising from our "General Delivery Conditions".



Sécheron Hasler GROUP
Smart. Safe. Swiss.